

On the tightness of bounds for transients of weak CSR expansions and periodicity transients of critical rows and columns of tropical matrix powers

Merlet, Glenn; Nowak, Thomas; Sergeev, Sergei

DOI:

[10.1080/03081087.2021.1878995](https://doi.org/10.1080/03081087.2021.1878995)

License:

Creative Commons: Attribution-NonCommercial (CC BY-NC)

Document Version

Peer reviewed version

Citation for published version (Harvard):

Merlet, G, Nowak, T & Sergeev, S 2021, 'On the tightness of bounds for transients of weak CSR expansions and periodicity transients of critical rows and columns of tropical matrix powers', *Linear and Multilinear Algebra*.
<https://doi.org/10.1080/03081087.2021.1878995>

[Link to publication on Research at Birmingham portal](#)

Publisher Rights Statement:

This is an Accepted Manuscript version of the following article, accepted for publication in *Linear and Multilinear Algebra*. Glenn Merlet, Thomas Nowak & Sergei Sergeev (2021) On the tightness of bounds for transients of weak CSR expansions and periodicity transients of critical rows and columns of tropical matrix powers, *Linear and Multilinear Algebra*, DOI: 10.1080/03081087.2021.1878995. It is deposited under the terms of the Creative Commons Attribution-NonCommercial License (<http://creativecommons.org/licenses/by-nc/4.0/>), which permits non-commercial re-use, distribution, and reproduction in any medium, provided the original work is properly cited.

General rights

Unless a licence is specified above, all rights (including copyright and moral rights) in this document are retained by the authors and/or the copyright holders. The express permission of the copyright holder must be obtained for any use of this material other than for purposes permitted by law.

- Users may freely distribute the URL that is used to identify this publication.
- Users may download and/or print one copy of the publication from the University of Birmingham research portal for the purpose of private study or non-commercial research.
- User may use extracts from the document in line with the concept of 'fair dealing' under the Copyright, Designs and Patents Act 1988 (?)
- Users may not further distribute the material nor use it for the purposes of commercial gain.

Where a licence is displayed above, please note the terms and conditions of the licence govern your use of this document.

When citing, please reference the published version.

Take down policy

While the University of Birmingham exercises care and attention in making items available there are rare occasions when an item has been uploaded in error or has been deemed to be commercially or otherwise sensitive.

If you believe that this is the case for this document, please contact UBIRA@lists.bham.ac.uk providing details and we will remove access to the work immediately and investigate.

On the Tightness of Bounds for Transients of Weak CSR Expansions and Periodicity Transients of Critical Rows and Columns of Tropical Matrix Powers[☆]

Glenn Merlet^a, Thomas Nowak^{b,1}, Sergeĭ Sergeev^{c,*}

^a*Aix Marseille Univ, CNRS, Centrale Marseille, I2M, Marseille, France*

^b*Université Paris-Saclay, CNRS, Orsay, France*

^c*University of Birmingham, School of Mathematics, Edgbaston B15 2TT, UK.*

Abstract

We study the transients of matrices in max-plus algebra. Our approach is based on the weak CSR expansion. Using this expansion, the transient can be expressed by $\max\{T_1, T_2\}$, where T_1 is the weak CSR threshold and T_2 is the time after which the purely pseudoperiodic CSR terms start to dominate in the expansion. Various bounds have been derived for T_1 and T_2 , naturally leading to the question which matrices, if any, attain these bounds.

In the present paper we characterize the matrices attaining two particular bounds on T_1 , which are generalizations of the bounds of Wielandt and Dulmage-Mendelsohn on the indices of non-weighted digraphs. This also leads to a characterization of tightness for the same bounds on the transients of critical rows and columns. The characterizations themselves are generalizations of those for the non-weighted case.

Keywords: Max-plus, matrix powers, transient, periodicity, digraphs.

AMS Classification: 15A18, 15A23, 90B35

[☆]This work was partially supported by ANR Perturbations grant (ANR-10-BLAN 0106). The work of S. Sergeev was also supported by EPSRC grant EP/P019676/1.

*Corresponding author. Email: sergiej@gmail.com

Email addresses: glenn.merlet@univ-amu.fr (Glenn Merlet), thomas.nowak@lri.fr (Thomas Nowak), sergiej@gmail.com (Sergeĭ Sergeev)

¹T. Nowak was with the École Normale Supérieure, Paris, France, when this work was initiated.

1. Introduction

Max-plus algebra is a version of linear algebra developed over the max-plus semiring, which is the set $\mathbb{R}_{\max} = \mathbb{R} \cup \{-\infty\}$ equipped with the operations $a \oplus b := \max\{a, b\}$ (additive) and $a \otimes b := a + b$ (multiplicative). This semiring has a zero $\mathbf{0} := -\infty$, neutral with respect to \oplus , and a unity $\mathbf{1} = 0$, neutral with respect to \otimes . The multiplicative operation is invertible, that is, for each $\alpha \neq \mathbf{0}$ there exists an element $\alpha^- = -\alpha$ such that $\alpha^- \otimes \alpha = \alpha \otimes \alpha^- = \mathbf{1}$.

These arithmetical operations are extended to matrices and vectors in the usual way. Matrix addition is defined by $(A \oplus B)_{i,j} = a_{i,j} \oplus b_{i,j}$ for two matrices $A = (a_{i,j})$ and $B = (b_{i,j})$ of equal dimensions, and matrix multiplication by $(A \otimes B)_{i,j} = \bigoplus_{k=1}^l a_{ik} \otimes b_{kj}$ for two matrices A and B of compatible dimensions. Here we are interested in tropical matrix powers:

$$A^t = \overbrace{A \otimes A \otimes A \cdots \otimes A}^{t \text{ times}}, \quad t \geq 1, \quad . \quad (1)$$

assuming that $A^0 = I$, the max-plus identity matrix, in which all diagonal entries are equal to $\mathbf{1} = 0$ and all off-diagonal entries are equal to $\mathbf{0} = -\infty$.

As we see, matrix powers are easy to define for natural t . As for negative t , the problem is that the set of max-plus matrices for which inverse exists is very scarce (see, e.g., [6] Theorem 1.1.3 for a complete description). However, we will make use of invertible max-plus diagonal matrices: matrices $D = (d_{i,j})$ in which $d_{i,i}$ are real for all i and $d_{i,j} = -\infty$ when $i \neq j$. The inverse of D , denoted by D^- , is also a diagonal matrix with diagonal entries equal to $d_{i,i}^-$ for all i , so that we have $D \otimes D^- = D^- \otimes D = I$.

In what follows, the multiplication sign \otimes will be always omitted in the case of matrix multiplication, but always kept in the case of multiplication

by scalars. In particular, we write $\lambda^{\otimes t} = \overbrace{\lambda \otimes \dots \otimes \lambda}^{t \text{ times}} = t\lambda$ and $\lambda^{\otimes 1/t} = \frac{1}{t}\lambda$ for $\lambda \in \mathbb{R}_{\max}$.

The fundamental result on tropical matrix powers [9] states that if A is irreducible then there exist a real λ and integers γ and T such that

$$\forall t \geq T: \quad A^{t+\gamma} = \lambda^{\otimes \gamma} \otimes A^t. \quad (2)$$

The smallest nonnegative T for which (2) holds is called the *transient* of matrix A , denoted by $T(A)$. The transient can be shown to be independent

of the choice of λ and γ . In fact, λ is the largest mean cycle weight in the weighted digraph described by A . Bounds on transients have been studied by many authors, e.g., Hartmann and Arguelles [13], Bouillard and Gaujal [4] Soto y Koelemeijer [22], Akian et al. [1], Charron-Bost et al. [7], and the authors [14]. The time behavior and complexity of several real systems can be reduced to determining the transient of max-plus matrices. These applications include communication networks [3], cyclic scheduling [10], link-reversal algorithms [8], network synchronizers [12], as well as transportation and manufacturing systems [2].

An analog of the ultimate pseudoperiodicity of irreducible max-plus matrices for real-valued non-negative matrices is provided by the Perron-Frobenius theorem. The largest mean cycle weight λ is analogous to the spectral radius of non-negative matrices. The spectral radius of stochastic matrices, i.e., non-negative matrices whose row sums are all 1, is equal to 1. The sequence of powers of an irreducible stochastic matrix is known to converge to a rank-1 stochastic matrix and the rate of convergence is known to depend on the matrix's spectral gap, i.e., the difference between its largest and its second largest eigenvalue. Similarly, the transient of an irreducible max-plus matrix depends on the difference between the largest and the second-largest mean cycle weight.

If all matrix entries in A are restricted to $\mathbf{0} = -\infty$ or $\mathbf{1} = 0$ then the tropical matrix algebra becomes Boolean matrix algebra (i.e., linear algebra over the Boolean semiring), and the associated digraph becomes unweighted. Powers of Boolean matrices have been thoroughly studied in combinatorics (see, e.g., [5]), and various bounds on their transient of periodicity, called index or exponent in these cases, have been obtained. One well-known application is the Frobenius coin problem, which can be seen as calculating the transient of a specifically constructed graph. For general connected graphs, Wielandt [23] proved the bound $(n-1)^2+1$ and Dulmage and Mendelsohn [11] proved $g(n-2) + n$, where g is the girth of the graph.

Note that the same problem can be considered locally: for each pair i, j , given γ and λ that work for (2), find the minimal $T_{i,j}$ such that

$$\forall t \geq T_{i,j}: \quad (A^{t+\gamma})_{i,j} = \lambda^{\otimes \gamma} \otimes (A^t)_{i,j}. \quad (3)$$

Denoting that minimal $T_{i,j}$ by $T_{i,j}(A)$, we can also consider $\max_{i \in [n]} T_{i,j}(A)$ and $\max_{j \in [n]} T_{i,j}(A)$. These quantities are called the *transient of the j th column* of A and the *transient of the i th row* of A , respectively. The bounds

for such transients can be much lower than those for $T(A)$, as it was shown by [15] in an important special case of critical rows and columns, i.e., in the case where the index of the row or column corresponds to a critical node (see Definition 2.7 below).

The eventual periodicity was reformulated and generalized by Sergeev and Schneider [19, 20] via the concept of CSR expansions. They observed that in the case of eventual periodicity of $\{A^t\}_{t \geq 1}$ there is a big enough T for which we have

$$\forall t \geq T: \quad A^t = CS^tR, \quad (4)$$

where C, S and R are constructed from A (see Definition 2.11 below) in such a way that CS^tR is a purely pseudoperiodic sequence (i.e. $CS^{t+\gamma}R = \lambda^{\otimes \gamma} \otimes CS^tR$ for any t and some λ and γ). The smallest T for which (4) holds is equal to $T(A)$.

In [14], we used this approach to unify and improve the known bounds on $T(A)$. To this aim, we introduced the so-called *weak CSR expansions*. Observe that, given any $A \in \mathbb{R}_{\max}^{n \times n}$, there exists a big enough T for which

$$\forall t \geq T: \quad A^t = CS^tR \oplus B^t. \quad (5)$$

Here C, S , and R are defined as in (4) and B is a matrix obtained from A by setting some entries to $\mathbf{0}$. The smallest number T for which (5) holds is called the weak CSR expansion threshold and denoted by $T_1(A, B)$. In this paper we consider only the case $B = B_N$, where all entries with an index corresponding to a critical node are set to $\mathbf{0}$ (see Definition 2.11 below). In this case $T_1(A, B_N)$ will be abbreviated to $T_1(A)$.

For irreducible *Boolean* matrices, $T(A)$ and $T_1(A, B_N)$ coincide. For reducible ones, they coincide, as soon as $T_1(A, B_N) \geq n$. This allows to hope for extensions of bounds on exponents of graph to T_1 in the framework of max-plus algebra. In particular, Wielandt and Dulmage-Mendelsohn bounds were extended in Theorem 4.1 of [14].

However, no information was given in [14] on the question of which classes of matrices attain these bounds for $T_1(A, B)$. For the index of digraphs, those results are well-known. In particular, the digraph attaining the Wielandt bound is unique up to renumbering the nodes, and the digraphs attaining the bound of Dulmage-Mendelsohn were studied by Shao [21]. The main results of the present paper are Theorem 3.1, which characterizes all matrices A (or all weighted digraphs) such that $T_1(A, B_N)$ attains the Dulmage-Mendelsohn bound, and Theorem 3.7, which characterizes those attaining the Wielandt

bound. Unfortunately, we have not been able to characterize the matrices that reach the bounds for other choices of B studied in [14].

On the other hand, in [15] we had proved that the same bounds (and others) also apply to the transient of a critical row or column of matrices. Theorems 3.6 and 3.10 characterize the matrices for which these bounds are reached.

The paper is organized as follows. After giving preliminary definitions and results in Section 2, we state our characterizations in Section 3.1 and give a quick overview of how to prove them. The characterizations for the Dulmage-Mendelsohn bound on the weak CSR threshold is then proved in Section 4 and that for the Wielandt bound in Section 5. Finally, in Section 6, we prove the characterizations for the transients of critical rows and columns.

2. Preliminaries

2.1. Digraphs and Walks

Most of the techniques for analyzing the max-plus matrix powers and their behavior are based on consideration of walks on the associated weighted digraphs. Hence it is essential to introduce the notion of weighted digraph associated with a given max-plus matrix, as well as the related notions of walks, connectivity, girth and cyclicity.

Definition 2.1 (Associated digraph, sub(di)graph). Let $A \in \mathbb{R}_{\max}^{n \times n}$. The *digraph associated with A* , denoted by $\mathcal{D}(A)$, is defined as the pair (N, E) where $N = \{1, \dots, n\}$ is the set of nodes and $E = \{(i, j) \in N \times N : a_{i,j} \neq \mathbf{0}\}$ is the set of arcs connecting these nodes. Arc (i, j) has *weight* $a_{i,j}$.

A digraph $\mathcal{D}' = (N', E')$ is called a *sub(di)graph* of $\mathcal{D} = (N, E)$ if $N' \subseteq N$ and $E' \subseteq E \cap (N' \times N')$.

Definition 2.2 (Walks). A sequence $i_0 \dots i_k$, where $i_0, \dots, i_k \in N$, is called a *walk* on a digraph $\mathcal{D} = (N, E)$ if for any $s: 1 \leq s \leq k$ the arc (i_{s-1}, i_s) is in E .

For a walk $W = i_0 \dots i_k$ we define the *length* of the walk as $l(W) := k$, which is the number of letters in that walk (as a sequence of letters) minus one.

If $i_0 = i_k$ then $W = i_0 \dots i_k$ is called *closed*.

A closed walk with no proper closed subwalk is called a *cycle*.

If $\mathcal{D} = \mathcal{D}(A)$ and $W = i_0 \dots i_k$ then the *weight* of W is defined as $p(W) := a_{i_0 i_1} \otimes \dots \otimes a_{i_{k-1} i_k}$.

Definition 2.3 (Walk sets). Let \mathcal{W} be a set of walks on a weighted digraph \mathcal{D} , and let \mathcal{G} be a subdigraph of \mathcal{D} . Denote $p(\mathcal{W}) := \max\{p(W) : W \in \mathcal{W}\}$ (the maximal weight of all walks in \mathcal{W}).

The following sets of walks will be particularly useful.

1. $\mathcal{W}^t(i \rightarrow j)$: the set of walks from i to j that have length t .
2. $\mathcal{W}^{t,\gamma}(i \rightarrow j)$: the set of walks from i to j that have length t modulo γ .
3. $\mathcal{W}^{t,\gamma}(i \xrightarrow{\mathcal{G}} j)$: the set of walks of $\mathcal{W}^{t,\gamma}(i \rightarrow j)$ that go through a node in \mathcal{G} .

Observe that a sequence of nodes is not necessarily a walk. Also observe that an easy way to change a walk into another walk is to remove closed subwalks from a given walk, or to replace a (possibly empty) subwalk by another walk with the same start and same end. This will be the main tool of this article.

The following optimal walk interpretation of matrix powers is well-known:

$$(A^t)_{i,j} = p(\mathcal{W}^t(i \rightarrow j)). \quad (6)$$

See, for example, [6, Example 1.2.3].

We now give some definitions related to connectivity in digraphs.

Definition 2.4 (Connectivity). A digraph $\mathcal{D} = (N, E)$ is called *strongly connected* if for each $i, j \in N$ there is a walk from i to j .

Maximal strongly connected component of \mathcal{D} , further abbreviated to *s.c.c.*, is a maximal strongly connected subgraph of \mathcal{D} .

A digraph is called *completely reducible* if for any pair of s.c.c. of \mathcal{D} there is no walk connecting a node of one s.c.c. to a node of another s.c.c.

Definition 2.5 (Maximal Girth). For a strongly connected digraph \mathcal{D} , the *girth* of \mathcal{D} is defined as the minimal length of a cycle in \mathcal{D} .

For a completely reducible digraph \mathcal{D} , the *maximal girth* of \mathcal{D} , denoted by $g(\mathcal{D})$, is defined as the maximal girth of the s.c.c.'s of \mathcal{D} .

Although we use the same notation $g(\mathcal{D})$, note that this is not what is usually called the girth of a reducible graph, namely the least common multiple of the girths of its s.c.c.'s, a quantity not used in this paper.

Definition 2.6 (Cyclicity). For a strongly connected graph \mathcal{D} , the *cyclicity* of \mathcal{D} , denoted by $\gamma(\mathcal{D})$, is defined as the greatest common divisor of all cycle

lengths of \mathcal{D} .

For a completely reducible digraph of \mathcal{D} , the *cyclicity* of \mathcal{D} is defined as the least common multiple of the cyclicity of the strongly connected components of \mathcal{D} .

In max-plus algebra we deal not only with $\mathcal{D}(A)$ but also with special subgraphs of it such as the critical graph of the following definition.

Definition 2.7 (Maximum cycle mean and critical graph). The *maximum cycle mean* of A is

$$\lambda(A) = \max_{i_1, \dots, i_k} (a_{i_1 i_2} \otimes \dots \otimes a_{i_{k-1} i_k} \otimes a_{i_k i_1})^{\otimes 1/k}. \quad (7)$$

The *critical graph* of A , denoted by $\mathcal{G}^c(A)$, is a subdigraph of $\mathcal{D}(A)$ consisting of all nodes and arcs of the cycles $i_1 \dots i_k i_1$ that attain the maximum in (7). Such nodes and arcs are also called *critical*.

Definition 2.8 (Visualization). We say that A is *visualized* if $a_{i,j} \leq \lambda(A)$ for all i and j and $a_{i,j} = \lambda(A)$ whenever (i, j) is an arc of $\mathcal{G}^c(A)$. It is *strictly visualized* if it is visualized and $a_{i,j} = \lambda(A)$ if and only if (i, j) is an arc of $\mathcal{G}^c(A)$.

A *scaling* of A is a matrix of the form $B = D^- A D$ where D is a diagonal matrix with finite diagonal entries. A *visualization* of A is a scaling that is visualized. Likewise, a *strict visualization* of A is a scaling that is strictly visualized.

Theorem 2.9 ([18]). *Every A with $\lambda(A) \neq \mathbf{0}$ has a strict visualization.*

2.2. Weak CSR Expansion

We now present important definitions, notations and facts related to the main theme of this work.

Definition 2.10 (Kleene star). Let $A \in \mathbb{R}_{\max}^{n \times n}$ with $\lambda(A) \leq \mathbf{1}$. Then

$$A^* := I \oplus A \oplus \dots \oplus A^{n-1}$$

is called the *Kleene star* of A . Recall that I denotes the max-plus identity matrix (which has $\mathbf{1}$ on the diagonal and $\mathbf{0}$ off the diagonal).

Definition 2.11 (CSR). Let $A \in \mathbb{R}_{\max}^{n \times n}$. If $\lambda(A) \neq \mathbf{0}$, set $M = ((\lambda(A)^- \otimes A)^\gamma)^*$, where γ is the cyclicity of $\mathcal{G}^c(A)$, and define matrices C, S and R by

$$c_{i,j} := \begin{cases} m_{i,j}, & \text{for } j \in \mathcal{G}^c(A), \\ \mathbf{0}, & \text{otherwise,} \end{cases}, \quad r_{i,j} := \begin{cases} m_{i,j}, & \text{for } i \in \mathcal{G}^c(A), \\ \mathbf{0}, & \text{otherwise,} \end{cases},$$

$$s_{i,j} := \begin{cases} a_{i,j}, & \text{for } (i,j) \in \mathcal{G}^c(A), \\ \mathbf{0}, & \text{otherwise.} \end{cases}$$

If $\lambda(A) = \mathbf{0}$, let CS^tR be the matrix in $\mathbb{R}_{\max}^{n \times n}$ with only $\mathbf{0}$ entries for any t .

This definition is best understood in combination with Proposition 2.16 part i, which gives an optimal walk interpretation of $(CS^tR[A])_{i,j}$: the maximal weight of walks connecting i to j that have length modulo γ . Optimal walk interpretation also gives an idea why we have “division” by $\lambda(A)$ in the definition of M and hence C and R : the lengths of corresponding optimal walks are not controlled. Informally speaking, CSR is related to turnpike theorems in a discrete deterministic case [1] at least in some optimal long walks most of the material should be concentrated on the critical graph so that A^t is determined by S^t for large enough t . This also shows why there is no “division” by $\lambda(A)$ in S .

Below we also deal with some auxiliary matrices, for which the CSR terms are (a priori) different from those derived from A . Therefore we will write $CS^tR[A]$ for a CSR term derived from A .

Definition 2.12 (B_N). The Nachtigall matrix $B = B_N$ is defined as the matrix whose entries are

$$(B_N)_{i,j} = \begin{cases} \mathbf{0}, & \text{if } i \text{ or } j \text{ is a critical node} \\ a_{i,j}, & \text{else.} \end{cases}$$

This is the most obvious choice of a matrix B that appears in a weak CSR expansion, since if $B = B_N$ then $B_{i,j}^t$ expresses the optimal weight of all walks that connect i to j and do not touch any critical node of A .

Definition 2.13 ($T_1(A) = T_1(A, B_N)$). The *weak CSR threshold* $T_1(A, B_N)$ is the least T , for which

$$A^t = CS^tR \oplus B_N^t, \quad t \geq T$$

holds. In the sequel, $T_1(A, B_N)$ is abbreviated to $T_1(A)$.

We will further work with the following two bounds on $T_1(A)$, which originate in the works on digraph exponents or indices of imprimitivity and (in the case of unweighted digraphs and matrix powers over Boolean algebra) are due to Wielandt [23] and Dulmage and Mendelsohn [11].

Definition 2.14 ($Wi(n)$ and $DM(g, n)$). For any $n \in \mathbb{N}$ (the set of natural numbers) and any $1 \leq g \leq n$, we define

$$Wi(n) = \begin{cases} 0, & \text{if } n = 1, \\ (n-1)^2 + 1, & \text{otherwise.} \end{cases} \quad (8)$$

$$DM(g, n) = g(n-2) + n.$$

Theorem 2.15 ([14] Theorem 4.1). For $A \in \mathbb{R}_{\max}^{n \times n}$ and $g = g(\mathcal{G}^c(A))$, we have: $T_1(A) \leq \min(Wi(n), DM(g, n))$.

Proposition 2.16 ([14],[20]). Let $A \in \mathbb{R}_{\max}^{n \times n}$ have $\lambda(A) = \mathbf{1}$.

(i) *CSR terms have the following optimal walk interpretation:*

$$(CS^t R[A])_{i,j} = p(\mathcal{W}^{t,\gamma}(i \xrightarrow{\mathcal{G}^c(A)} j)) \quad \forall i, j \in \{1, \dots, n\}$$

for γ being any multiple of $\gamma(\mathcal{G}^c(A))$.

- (ii) $CS^{t+\gamma} R[A] = CS^t R[A]$ for all $t \geq 1$ (**periodicity**).
- (iii) $CS^{t_1} R[A] CS^{t_2} R[A] = CS^{t_1+t_2} R[A]$ for all $t_1, t_2 \geq 1$ (**group law**).
- (iv) $\lim_{k \rightarrow \infty} A^{t+k\gamma} = CS^t R[A] \quad \forall t > 0$. (**limit property**)
- (v) $A(CS^t R[A]) = (CS^t R[A])A = CS^{t+1} R[A]$

Parts (iii) and (v) also hold with general $\lambda(A)$.

Proof. (i): This property follows from [20] Theorem 3.3, or [14] Theorem 6.1 where a more general statement is given.

(ii), (iii): These properties are shown in [20] Proposition 3.2 and Theorem 3.4.

(iv): It is obvious that $\lambda(B) < \mathbf{1}$ and therefore $\lim B^t = \mathbf{0}$. The claim then follows from the weak CSR expansion $A^t = CS^t R \oplus B^t$ and the periodicity of $\{CS^t R\}_{t \geq 1}$ (ii).

(v) can be deduced from (iv) (as could (iii)).

Extension to general $\lambda(A)$ follows from the homogeneity of (iii) and (v). \square

Proposition 2.17 below is an extended version of Proposition 2.16 part (i). In particular, it builds on the idea that the CSR terms in Definition 2.11 can be defined using any completely reducible subgraph of $\mathcal{G}^c(A)$ instead of the full $\mathcal{G}^c(A)$.

Proposition 2.17 (cf. [14], Theorem 6.1). *Let $A \in \mathbb{R}_{\max}^{n \times n}$ be a matrix with $\lambda(A) = \mathbf{1}$ and C, S and R be the CSR terms of A with respect to some completely reducible subgraph \mathcal{G} of the critical graph $\mathcal{G}^c(A)$.*

Let γ be a multiple of $\gamma(\mathcal{G})$ and \mathcal{N} a set of some nodes of \mathcal{G} that contains at least one node of every s.c.c. of \mathcal{G} .

Then we have, for any i, j and $t \in \mathbb{N}$:

$$(CS^tR)_{i,j} = p \left(\mathcal{W}^{t,\gamma}(i \xrightarrow{\mathcal{N}} j) \right), \quad (9)$$

where $\mathcal{W}^{t,\gamma}(i \xrightarrow{\mathcal{N}} j) := \left\{ W \in \mathcal{W}(i \xrightarrow{\mathcal{N}} j) \mid l(W) \equiv t \pmod{\gamma} \right\}$

3. Theorem Statements and Proof Strategy

3.1. Statements

For any matrix $A \in \mathbb{R}_{\max}^{n \times n}$ and any $1 \leq g \leq n$, we define the following matrices.

$$(A_1)_{i,j} = \begin{cases} a_{i,j} & \text{if } j = i + 1 \text{ and } 1 \leq i \leq n - 1 \\ & \text{or } (i, j) \in \{(n, 1), (g, 1)\}, \\ \mathbf{0} & \text{otherwise.} \end{cases} \quad (10)$$

$$(B_1)_{i,j} = \begin{cases} a_{i,j}, & \text{if } i > g, j > g \text{ and } j \equiv_g i + 1 \\ \mathbf{0}, & \text{otherwise} \end{cases} \quad (11)$$

$$(A_2)_{i,j} = \begin{cases} \mathbf{0}, & \text{if } (A_1 \oplus B_1)_{i,j} > \mathbf{0}, \\ a_{i,j}, & \text{otherwise.} \end{cases} \quad (12)$$

Figure 1 shows an example of A_1 and B_1 . The definitions of A_1 , B_1 and A_2 imply that

$$A = A_1 \oplus B_1 \oplus A_2. \quad (13)$$

We write $A < B$ if for all i, j , $a_{i,j} < b_{i,j}$ or $a_{i,j} = b_{i,j} = -\infty$.

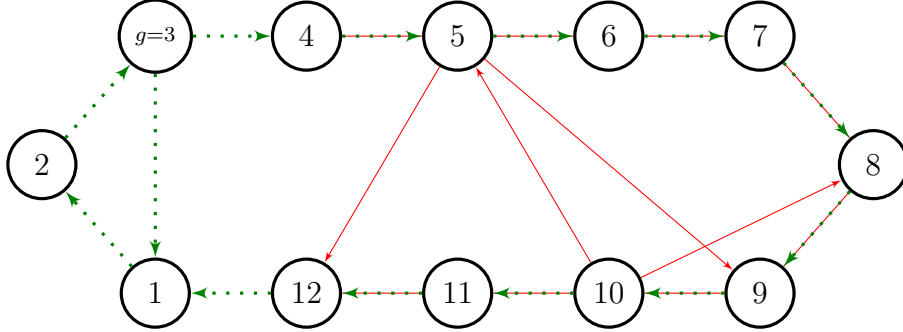

Figure 1: Example of the digraph of A_1 (dotted arcs) and B_1 (solid arcs) For B_1 , only some of the arcs are shown.

Theorem 3.1. *Let $A \in \mathbb{R}_{\max}^{n \times n}$ with $g = g(\mathcal{G}^c(A)) \geq 2$. Then A satisfies $T_1(A) = \text{DM}(g, n)$ if and only if there exists a renumbering of nodes such that the following conditions hold.*

1. g and n are coprime;
2. $\mathcal{G}^c(A)$ is strongly connected with a unique critical cycle of length g up to choice of its first node;
3. $1 \cdots g1$ is critical
4. $A_2 < \text{CSR}[A_1]$;
5. $\lambda(A)^{\otimes(j-i-1)} \otimes (B_1)_{i,j} < (A_1)_{i,j}^{j-i}$ when $j > i + 1$, $i > g$ and $j \equiv_g (i + 1)$;
6. $(B_1)_{g+1,n}^{\text{DM}(g,n)-1} < (\text{CS}^{\text{DM}(g,n)-1} R)_{g+1,n}[A_1]$,

where A_1 , B_1 and A_2 are defined as in (10), (11) and (12).

The renumbering satisfying Conditions 1–6 is necessarily unique. More precisely, it is the only one that ensures that

- $1 \cdots n1$ is an Hamiltonian cycle of $\mathcal{D}(A)$ with the largest weight, which is unique up to choice of its first node.
- $1 \cdots g1$ is critical.

Remark 3.2. Note that in the above theorem we do not assume that A is irreducible. The same is true about all the statements in this section. However, it follows from Condition 4 that A_1 is irreducible (and aperiodic) and thus, so is A .

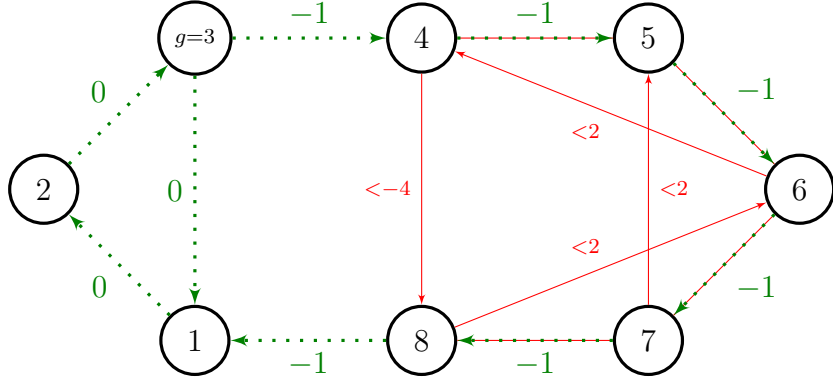

Figure 2: Digraph of the example with $g = 3$ and $n = 8$

Remark 3.3. The case $g = 1$ turns out to be much more complicated. Although some results do apply (e.g. Proposition 4.2) we were not able to characterize the matrices reaching the bound. Notice that already in the Boolean case the situation is more complicated and not completely understood (see [21]).

On the other hand, if $n < 2g$ the situation is simpler : $j \equiv_g i + 1$ with $i, j > g$ holds if and only if $j = i + 1$ and $i, j > g$. In this case Conditions 5 and 6 above hold automatically. For Condition 6, note that $\mathcal{D}(B_1)$ is acyclic hence $B_1^{n-g} = \mathbf{0}$.

Remark 3.4. The index of $\mathcal{D}(A_1)$ reaches the bound $DM(g, n)$. It is easy to recover the characterization of such graphs obtained in [21] from the theorem.

Let us see what Theorem 3.1 means on an example.

Example 3.5. We fix $g = 3$ and $n = 8$. The theorem says that any matrix of this type that reaches the bound can be decomposed as in Equations (10), (11),(12) with 1231 as critical cycle. Let us assume that $(A_1)_{1,2} = (A_1)_{2,3} = (A_1)_{3,1} = 0$ and all other finite entries of A_1 equal -1 . (See. Figure 2.)

Let us compute $CSR[A_1]$ with Scicoslab (a fork from Scilab which incor-

porates the MaxPlus Toolbox). We get

$$CSR[A_1] = \begin{pmatrix} -12 & 0 & -6 & -13 & -2 & -9 & -16 & -5 \\ -6 & -12 & 0 & -7 & -14 & -3 & -10 & -17 \\ 0 & -6 & -12 & -1 & -8 & -15 & -4 & -11 \\ -11 & -17 & -5 & -12 & -19 & -8 & -15 & -22 \\ -4 & -10 & -16 & -5 & -12 & -19 & -8 & -15 \\ -15 & -3 & -9 & -16 & -5 & -12 & -19 & -8 \\ -8 & -14 & -2 & -9 & -16 & -5 & -12 & -19 \\ -1 & -7 & -13 & -2 & -9 & -16 & -5 & -12 \end{pmatrix}$$

The colored entries are those for which $(A_2)_{i,j} = \mathbf{0}$ and thus Condition 4 is trivial.

For those entries, Conditions 2 and 3 mean that $(B_1)_{6,4}, (B_1)_{7,5}, (B_1)_{8,6} < 2$, while Condition 5 means that $(B_1)_{4,8} < -4$.

Finally, get

$$T_1(A) = \text{DM}(g, n) \iff \left\{ \begin{array}{l} (B_1)_{4,8}^{25} < -22 \text{ (Condition 6)} \\ A < \begin{pmatrix} -12 & 0^= & -6 & -13 & -2 & -9 & -16 & -5 \\ -6 & -12 & 0^= & -7 & -14 & -3 & -10 & -17 \\ 0^= & -6 & -12 & -1^= & -8 & -15 & -4 & -11 \\ -11 & -17 & -5 & -12 & -1^= & -8 & -15 & -4 \\ -4 & -10 & -16 & -5 & -12 & -1^= & -8 & -15 \\ -15 & -3 & -9 & 2 & -5 & -12 & -1^= & -8 \\ -8 & -14 & -2 & -9 & 2 & -5 & -12 & -1^= \\ -1^= & -7 & -13 & -2 & -9 & 2 & -5 & -12 \end{pmatrix} \end{array} \right. ,$$

where the matrix inequality means that each entry of A should be equal to the corresponding entry if it is denoted by $=$ and strictly less than it otherwise.

A computation of B_1^{25} shows that Condition 6 can not be removed. For instance, it will be satisfied for $(B_1)_{6,4} = (B_1)_{7,5} = (B_1)_{8,6} = -1$ not for $(B_1)_{6,4} = (B_1)_{7,5} = (B_1)_{8,6} = 0$.

In [15][Lemma 8.2], we have noticed that for any matrix A with $\lambda(A) \neq \mathbf{0}$, the maximal transient of its critical rows or columns is at least the index of its critical graph, so that if the index of $\mathcal{G}^c(A)$ reaches the bound, so does the transient of one row and one column. The following shows that the converse is also true.

Theorem 3.6. *Let $A \in \mathbb{R}_{\max}^{n \times n}$ and $g = g(\mathcal{G}^c(A))$. Then the transient of the critical rows and columns of A is equal to $\text{DM}(g, n)$ if and only if its critical graph has index $\text{DM}(g, n)$.*

Theorem 3.7. *Let $A \in \mathbb{R}_{\max}^{n \times n}$. Then, $T_1(A) = \text{Wi}(n)$ if and only if there exists a renumbering of nodes such that*

1. $g(\mathcal{G}^c(A)) = n - 1$ and $1 \cdots (n - 1)1$ is critical, or $g(\mathcal{G}^c(A)) = n$ and $1 \cdots n1$ is critical,
2. $A_2 < \text{CSR}[A_1]$,

where A_1 and A_2 are defined as in (10) and (12) with $g = n - 1$ in both cases.

The renumbering satisfying these conditions is necessarily unique. More precisely, it is the only one that ensures that

- $1 \cdots n1$ is an Hamiltonian cycle with the largest weight, which is unique up to choice of its first node.
- $1 \cdots (n - 1)1$ is a cycle of length $n - 1$ with the largest weight, which is unique up to choice of its first node.

Remark 3.8. The digraph $\mathcal{D}(A_1)$ is exactly the unique (up to renumbering) digraph whose index reaches the bound $\text{Wi}(n)$.

Let us see what Theorem 3.7 means on an example.

Example 3.9. We fix $g = n = 8$. The theorem says that any matrix of this type that reaches the bound can be decomposed as in Equations (10) and (12) with $g = 7$. Let us assume that $(A_1)_{i,i+1} = (A_1)_{8,1} = 0$ and $(A_1)_{7,1} = -1$. (See. Figure 3.)

Let us compute $\text{CSR}[A_1]$ with Scicoslab. We get

$$\text{CSR}[A_1] = \begin{pmatrix} -7 & 0 & -1 & -2 & -3 & -4 & -5 & -6 \\ -6 & -7 & 0 & -1 & -2 & -3 & -4 & -5 \\ -5 & -6 & -7 & 0 & -1 & -2 & -3 & -4 \\ -4 & -5 & -6 & -7 & 0 & -1 & -2 & -3 \\ -3 & -4 & -5 & -6 & -7 & 0 & -1 & -2 \\ -2 & -3 & -4 & -5 & -6 & -7 & 0 & -1 \\ -1 & -2 & -3 & -4 & -5 & -6 & -7 & 0 \\ 0 & -1 & -2 & -3 & -4 & -5 & -6 & -7 \end{pmatrix}$$

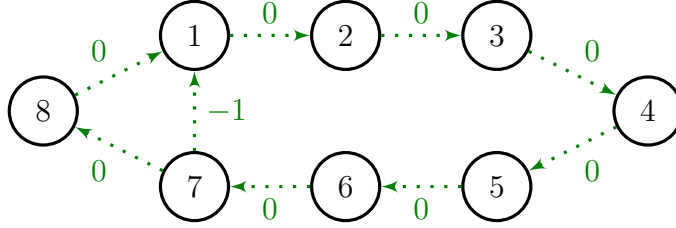

Figure 3: Digraph of the example with $g = n = 8$

The colored entries are those for which $A_{i,j} = (A_1)_{i,j}$ and thus there is nothing to check. A satisfies $T_1(A) = \text{Wi}(8)$ if and only if each other entry of A is strictly less than the corresponding entry of $\text{CSR}[A_1]$.

For the transient of critical rows or columns, we get:

Theorem 3.10. *Let $A \in \mathbb{R}_{\max}^{n \times n}$. Then the transient of the critical rows and columns of A is equal to $\text{Wi}(n)$ if and only if it is of the form $A = A_1 \oplus A_2$ such that the index of $\mathcal{D}(A_1)$ is $\text{Wi}(n)$, A_1 has a critical Hamiltonian cycle, and $A_2 < \text{CSR}[A_1]$.*

In contrast with the previous case, the critical graph need not have index $\text{Wi}(n)$. It can also be a Hamiltonian cycle, and only $\mathcal{D}(A_1)$ has index $\text{Wi}(n)$.

3.2. Overview of Proofs

Each of the next section is devoted to the proof of one of the main theorems (Theorem 3.1 and 3.7). The proof's strategy is the same for both theorems. It relies on the classical interpretation of entries of powers as weight of walks (cf. Equations (6) and (9)).

The necessity of the conditions is proved in 3 steps :

- Firstly, we use (slight refinements of) the results of [14] to prove properties of the critical graph. (Proposition 4.2)
- Then we introduce a special type of walks with given start and end nodes, which we call 'interesting walks'. Loosely speaking, these walks are optimal in terms of both weight and length (Definition 4.8). The structure of interesting walks is then studied in Propositions 4.9, 4.11 and 5.1. In particular, interesting walks contain a Hamiltonian cycle that gives the renumbering of nodes up to where to start. The start is determined by the critical nodes.

- Finally, we use our results on the structure of interesting walks to show that if one condition is not fulfilled, then one can build new shorter walks and thus the interesting walk would not be optimal, either in terms of weight, or length.

The proof of the sufficiency is based on the fact that the index of $\mathcal{D}(A_1)$ reaches the bound and the following perturbation lemma, which will also be used in the proof of necessity and we think is interesting for its own sake.

Lemma 3.11 (Perturbation lemma). *If $A = A_1 \oplus A_2$ with $A_1, A_2 \in \mathbb{R}_{\max}^{n \times n}$ such that $A_2 < CSR[A_1]$, then, we have $\lambda(A) = \lambda(A_1)$, $\mathcal{G}^c(A) = \mathcal{G}^c(A_1)$, $CS^tR[A] = CS^tR[A_1]$ for all t and $T_1(A) = T_1(A_1)$.*

This lemma will be proved, together with all other statements, in the next section.

4. Matrices attaining the Dulmage-Mendelsohn Bound

This section will be devoted to the proof of Theorem 3.1. In the rest of the work we assume $\lambda(A) = \mathbf{1}$ (because neither $T_1(A)$, nor the conditions of the theorem are modified if A is multiplied by a scalar) and set $g := g(\mathcal{G}^c(A))$.

Observe that $\lambda(A) = \mathbf{1}$ ensures that all closed walk have nonpositive weight, so that removing a closed subwalk from a given walk can only increase its weight. A fact that we will use extensively in this paper.

4.1. Perturbation Lemmas

In this section, we prove two lemmas, to be used in both ways of the equivalence. The first one was announced at the end of Section 3.1.

If for two matrices $A = (a_{i,j})_{i,j=1}^n$ and $B = (b_{i,j})_{i,j=1}^n$ we have $a_{i,j} \leq b_{i,j}$ for all i, j and that $a_{i,j} = b_{i,j} \Rightarrow a_{i,j} = b_{i,j} = -\infty$ then we write $A < B$. Observe that if $A < B$ and $C \leq D$ then $A \otimes C < B \otimes D$ and $C \otimes A < D \otimes B$.

Proof of Perturbation Lemma 3.11. If $\lambda(A_1) = \mathbf{0}$, then $A_2 = \mathbf{0}$, $A = A_1$ and there is nothing to prove. Otherwise, since $A_2 < CSR[A_1]$ is invariant under $A \mapsto \lambda \otimes A$, we assume without loss of generality that $\lambda(A_1) = \mathbf{1}$.

To prove the first equalities, consider a diagonal matrix D that provides a visualization scaling for A_1 . Then we obtain $D^-AD = D^-A_1D \oplus D^-A_2D$ where $D^-A_2D < D^-CSR[A_1]D \leq \mathbf{1}$. So D^-AD is visualized and $(D^-AD)_{i,j} = \mathbf{1}$ if and only if $(D^-A_1D)_{i,j} = \mathbf{1}$, which implies that

$\lambda(A) = \mathbf{1} = \lambda(A_1)$ and $\mathcal{G}^c(A) = \mathcal{G}^c(A_1)$, which are the first two equalities in the statement of Lemma 3.11.

To prove the remaining two equalities, let us first prove the following statement by induction:

$$\forall t \geq 1 \exists R_t : A^t = A_1^t \oplus R_t, \quad \text{where } R_t < CS^t R[A_1]. \quad (14)$$

For $t = 1$, set $R_1 = A_2$.

Suppose that (14) holds. Let us prove that it also holds when t is replaced by $t + 1$. We have

$$A^{t+1} = (A_1 \oplus R_1)(A_1^t \oplus R_t) = A_1^{t+1} \oplus R_1 A_1^t \oplus A_1 R_t \oplus R_1 R_t. \quad (15)$$

We bound from above the last three terms on the right-hand side of (15).

We have:

1. $R_1 A_1^t < CSR[A_1] A_1^t = CS^{t+1} R[A_1]$. by Proposition 2.16 part (v)
2. $A_1 R_t < A_1 CS^t R[A_1] = CS^{t+1} R[A_1]$, by Proposition 2.16 part (v).
3. $R_1 R_t < CSR[A_1] CS^t R[A_1] = CS^{t+1} R[A_1]$, by Proposition 2.16 part (iii).

Thus $A^{t+1} = A_1^{t+1} \oplus R_{t+1}$ where $R_{t+1} = R_1 A_1^t \oplus A_1 R_t \oplus R_1 R_t$ satisfies $R_{t+1} < CS^{t+1} R$.

Observe that $A^t = A_1^t$ for $t \geq T_1(A_1)$. Indeed, for any such t ,

$$\begin{aligned} A^t &= A_1^t \oplus R_t = CS^t R[A_1] \oplus B^t[A_1] \oplus R_t \\ &= CS^t R[A_1] \oplus B^t[A_1] = A_1^t. \end{aligned}$$

From this equality, the periodicity of CSR and the observation that $\lim_{k \rightarrow \infty} ((B[A_1])^{t+k\sigma}) = \mathbf{0}$ since $\lambda(B[A_1]) < \mathbf{1}$, we deduce that A and A_1 have the same CSR since

$$CS^t R[A] = \lim_{k \rightarrow \infty} A^{t+k\sigma} = \lim_{k \rightarrow \infty} A_1^{t+k\sigma} = CS^t R[A_1],$$

where σ is the cyclicity of $\mathcal{G}^c(A)$. Thus $CS^t R[A] = CS^t R[A_1]$ for all t .

To prove the remaining equality $T_1(A) = T_1(A_1)$, we first observe that $(B^t[A])_{i,j} \leq (A^t)_{i,j} \leq (CS^t R[A] \oplus B^t[A])_{i,j}$, and hence

$$(A^t)_{i,j} \neq (CS^t R[A] \oplus B^t[A])_{i,j} \Leftrightarrow (A^t)_{i,j} < (CS^t R[A])_{i,j}.$$

Next we use that $(B^t[A_1])_{i,j} \leq (A_1^t)_{i,j} \leq (CS^tR[A_1] \oplus B^t[A_1])_{i,j}$, that $A^t = A_1^t \oplus R_t$ where $R_t < CS^tR[A_1]$, and that $CS^tR[A_1] = CS^tR[A]$, so that we have the following equivalences:

$$\begin{aligned} (A^t)_{i,j} \neq (CS^tR[A] \oplus B^t[A])_{i,j} &\Leftrightarrow (A^t)_{i,j} < (CS^tR[A])_{i,j} \Leftrightarrow (A_1^t)_{i,j} \oplus (R_t)_{i,j} < (CS^tR[A_1])_{i,j} \\ &\Leftrightarrow (A_1^t)_{i,j} < (CS^tR[A_1])_{i,j} \Leftrightarrow (A_1^t)_{i,j} \neq (CS^tR[A_1] \oplus B^t[A_1])_{i,j}, \end{aligned}$$

thus $T_1(A) = T_1(A_1)$. \square

In this subsection and the next one, we will denote by Z_0 the subgraph consisting of the nodes and edges of the cycle $1 \cdots g1$.

Lemma 4.1. *Let A_1, B_1, A_2 be defined from the same matrix A by Equations (10), (11) and (12). Assume that Conditions 1 to 5 of Theorem 3.1 are satisfied, that is $\mathcal{G}^c(A)$ is strongly connected and contains Z_0 , g and n are coprime, $A_2 < CSR[A_1]$ and B_1 satisfies Condition 5. Then $CS^tR[A_1] = CS^tR[A_1 \oplus B_1]$ for all t .*

Proof. As in the first paragraph of the proof of Lemma 3.11 consider a diagonal matrix providing a visualization scaling for A_1 , assuming without loss of generality that $\lambda(A_1) = \mathbf{1}$. We then have $D^-A_2D < D^-CSR[A_1]D \leq \mathbf{1}$, and this shows that all arcs of $\mathcal{D}(A_2)$ are non-critical, hence $\mathcal{G}^c(A) = \mathcal{G}^c(A_1 \oplus B_1)$. In particular, $\mathcal{G}^c(A_1 \oplus B_1)$ is strongly connected and contains all edges of $1 \cdots g1$. The same is true about $\mathcal{G}^c(A_1)$, and we also have $\lambda(A_1 \oplus B_1) = \mathbf{1}$.

Recasting the above statement about CSR in terms of walks with Proposition 2.17 we have to prove for any $k, l \in \{1, \dots, n\}$ that

$$\max\{p(W) : W \in \mathcal{W}^{t,g}(k \xrightarrow{Z_0} l)[A_1]\} = \max\{p(W) : W \in \mathcal{W}^{t,g}(k \xrightarrow{Z_0} l)[A_1 \oplus B_1]\},$$

Since $A_1 \leq A_1 \oplus B_1$, we have the inequality

$$\max\{p(W) : W \in \mathcal{W}^{t,g}(k \xrightarrow{Z_0} l)[A_1]\} \leq \max\{p(W) : W \in \mathcal{W}^{t,g}(k \xrightarrow{Z_0} l)[A_1 \oplus B_1]\},$$

To prove the opposite, we need to take an arbitrary walk $W \in \mathcal{W}^{t,g}(k \xrightarrow{Z_0} l)[A_1 \oplus B_1]$ and prove that there exists a walk $W' \in \mathcal{W}^{t,g}(k \xrightarrow{Z_0} l)[A_1]$ such that $p(W) \leq p(W')$.

There are two kinds of arcs in W that may not be in $\mathcal{D}(A_1)$.

A. ij with $j > i + 1 > g + 1$ and $j \equiv_g i + 1$. In this case, we can replace ij by the path $i(i + 1) \cdots j$. The resulting walk visits even more nodes and

hence will go through a node of $\mathcal{G}^c(A_1)$. It has the same length modulo g . Due to Condition 5 of Theorem 3.1, its weight is not smaller than $p(W)$. Thus we can assume that W does not contain such arcs.

B. ij with $j < i$ and $j \equiv_g i + 1$.

Since we assumed that W contains no arc kl s.t. $l > k + 1$, the only arc that go from a node to a larger node are of type $k, k + 1$, thus if a subwalk of W goes from i to $s > i$ it goes through all nodes numbered between i and s .

If W goes to Z_0 after arc ij , it has to go through i again before reaching Z_0 , because the only arc to reach Z_0 from $\mathcal{D}(B_1)$ is $n1$. In this case, define W_1 as the closed subwalk that starts with the arc ij and follows W until it goes back to i .

If W does not go to Z_0 after arc ij , it has to come from Z_0 before, so it has to go through $g, g + 1$ which is the only arc leaving Z_0 . So, it has been in j before reaching i and arc ij . Then, define W_1 as the closed subwalk that starts with the last occurrence of j before arc ij and follows W until it goes back to i .

In both cases, W_1 lives on $\mathcal{D}(B_1)$ so its length is divisible by g and it can be removed from W .

The resulting walk has the same length modulo g , goes through a node of Z_0 and has larger weight than $p(W)$.

Iterating the process, we build the W' we are looking for. \square

4.2. Proof of Sufficiency

Let us now prove that Conditions 1–6 imply $T_1(A) = \text{DM}(g, n)$. We assume that the conditions are satisfied.

By Lemmas 3.11 and 4.1, we have $CSR[A] = CSR[A_1 \oplus B_1] = CSR[A_1]$.

As $A_2 < CSR[A_1 \oplus B_1]$ (Condition 4 and Lemma 4.1), by Lemma 3.11 we have $T_1(A) = T_1(A_1 \oplus B_1)$ so we can assume that $A_2 = \mathbf{0}$ and we do it from now on.

Entry $A_{g+1,n}^{\text{DM}(g,n)-1}$ is the largest weight of a walk W from $g + 1$ to n with length $\text{DM}(g, n) - 1$. Let us prove $p(W) < (CS^{n-1}R)_{g+1,n}[A]$, which ensures that $T_1(A, B) \geq \text{DM}(g, n)$, since in this case $A_{g+1,n}^t < (CS^tR)[A] \oplus B^t[A]_{g+1,n}$ for $t = \text{DM}(g, n) - 1$ (also recalling that $(CS^tR)[A] = (CS^{n-1}R)[A]$ by the periodicity of CSR). The other inequality follows from Theorem 2.15.

Case 1. If W does not go through Z_0 , then it is a walk on $\mathcal{D}(B_1)$ and $p(W) = (B_1)_{g+1,n}^{\text{DM}(g,n)-1}$. Using Condition 6, we conclude that $p(W) < (CS^{n-1}R)_{g+1,n}[A]$.

Case 2. Assume now that W goes through Z_0 and contains an arc (i, j) such that $j > i + 1$, $i > g$ and $j \equiv_g (i + 1)$. Then we can replace this arc by the path $i(i + 1) \cdots j$ thus obtaining a new walk W' . Using Condition 5, we conclude that $p(W) < p(W')$. But, we also have $p(W') \leq (CS^{n-1}R)_{g+1,n}[A]$, since W' visits a node of Z_0 and has length $n - 1$ modulo g . Thus $p(W) < p(W') \leq (CS^{n-1}R)_{g+1,n}[A]$.

Case 3. Assume that W goes through Z_0 and does not contain an arc (i, j) such that $j > i + 1$, $i > g$ and $j \equiv_g (i + 1)$. Then W can be decomposed into a path from $g + 1$ to n , and some cycles. Since we assumed that $A_2 = \mathbf{0}$ and W contains no arc with $j > i + 1 > g$, the only path from $g + 1$ to n is the path that follows the numbers and has length $n - 1 - g$, so that the total length of the cycles is $DM(g, n) - 1 - (n - 1 - g) = g(n - 1)$.

Since W goes through a node of Z_0 , and $1 \cdots n1$ is the only cycle that connects Z_0 and $\mathcal{D}(B_1)$, the cycle decomposition of W contains at least one copy of the cycle $1 \cdots n1$. But, again since $A_2 = \mathbf{0}$, $1 \cdots n1$ is the only cycle whose length n is not a multiple of g . As this length is, moreover, coprime with g , the walk should contain at least g copies of the cycle $1 \cdots n1$. But then their total length is $gn > g(n - 1)$, a contradiction. Hence this case is impossible, and the attainment of Dulmage-Mendelsohn bound has been proved for all possible cases.

4.3. Critical Graph

The end of the section will be devoted to the proof of the necessity of Conditions 1–6, along the lines presented in Section 3.2.

In this subsection, we prove the following proposition.

Proposition 4.2. *If $T_1(A) = DM(g, n)$, then $\mathcal{G}^c(A)$ is strongly connected and contains only one cycle of length g up to choice of its first node.*

To prove Proposition 4.2, we will use techniques from [14] related to CSR expansions and walks. We will first recall the main statements that will be required, and then the proof of Proposition 4.2 will be given after the statement of Proposition 4.7.

Using Proposition 2.17, we can define CSR terms using a s.c.c. of $\mathcal{G}^c(A)$ rather than the whole $\mathcal{G}^c(A)$, since any s.c.c. of $\mathcal{G}^c(A)$ is a completely reducible subgraph of $\mathcal{G}^c(A)$. Following [14] let $\mathcal{G}_1, \dots, \mathcal{G}_l$ be the s.c.c.'s of $\mathcal{G}^c(A)$ with node sets N_1, \dots, N_l , and let $C_{\mathcal{G}_1}, S_{\mathcal{G}_1}, R_{\mathcal{G}_1}$ be the CSR terms defined with respect to \mathcal{G}_1 . Let $A^{(1)} = A$, and for $\nu = 2, \dots, l$ define a matrix

$A^{(\nu)}$ by setting the entries of A with rows and columns in $N_1 \cup \dots \cup N_{\nu-1}$ to $\mathbf{0}$, and let $C_{\mathcal{G}_\nu}$, $S_{\mathcal{G}_\nu}$, $R_{\mathcal{G}_\nu}$ be the CSR terms defined with respect to \mathcal{G}_ν in $A^{(\nu)}$. By the *dimension* of $A^{(\nu)}$ we will mean the number of elements in $N \setminus (N_1 \cup \dots \cup N_{\nu-1})$.

Proposition 4.3 ([14], Corollary 6.3). *If $\mathcal{G}_1, \dots, \mathcal{G}_l$ are the s.c.c.'s of $\mathcal{G}^c(A)$, then we have:*

$$CS^tR = \bigoplus_{\nu=1}^l C_{\mathcal{G}_\nu} S_{\mathcal{G}_\nu}^t R_{\mathcal{G}_\nu}. \quad (16)$$

Let us now prove the following bound on $T_1(A)$:

Proposition 4.4. *Let n_ν for $\nu = 1, \dots, l$ be the dimension of $A^{(\nu)}$, and g_ν for $\nu = 1, \dots, l$ be the girth of \mathcal{G}_ν^c . Then*

$$T_1(A) \leq \max_{\nu=1, \dots, l} \text{DM}(g_\nu, n_\nu). \quad (17)$$

Proof. For each $\nu = 1, \dots, l$, the weak CSR expansion applied to $A^{(\nu)}$ reads

$$(A^{(\nu)})^t = C_{\mathcal{G}_\nu^c} (S_{\mathcal{G}_\nu^c})^t R_{\mathcal{G}_\nu^c} \oplus (A^{(\nu+1)})^t, \quad t \geq T. \quad (18)$$

The smallest T for which the weak CSR expansion (18) holds is bounded by $\text{DM}(g_\nu, n_\nu)$ by Theorem 2.15. If $t \geq \max_{\nu=1, \dots, l} \text{DM}(g_\nu, n_\nu)$ then (18) holds for all $\nu = 1, \dots, l$ and by successive replacement, we have:

$$A^t = \bigoplus_{\nu=1}^l C_{\mathcal{G}_\nu^c} (S_{\mathcal{G}_\nu^c})^t R_{\mathcal{G}_\nu^c} \oplus (A^{(l+1)})^t, \quad (19)$$

Observing that $A^{(l+1)} = B$ and that the CSR terms sum up to CS^tR by Proposition 4.3 we see that (19) is exactly the weak CSR expansion $A^t = CS^tR \oplus B^t$. \square

Bounds for $T_1(A)$ in [14] are based on the concept of the cycle removal threshold defined as follows.

Definition 4.5. Let \mathcal{G} be a subgraph of $\mathcal{D}(A)$ and $\gamma \in \mathbb{N}$.

The *cycle removal threshold* $T_{cr}^\gamma(\mathcal{G})$ of \mathcal{G} is the smallest nonnegative integer T for which the following holds: for all walks $W \in \mathcal{W}(i \xrightarrow{\mathcal{G}} j)$ with length $\geq T$, there is a walk $V \in \mathcal{W}(i \xrightarrow{\mathcal{G}} j)$ obtained from W by removing cycles and possibly inserting cycles of \mathcal{G} such that $l(V) \equiv l(W) \pmod{\gamma}$ and $l(V) \leq T$.

The idea behind this definition is to be able to shorten an optimal walk while keeping it optimal and keeping its length modulo γ , thus proving inequalities between CS^tR and A^t .

The following proposition is stated in [14] and proved there by “arithmetical method”.

Proposition 4.6 ([14], Proposition 9.5). *For $A \in \mathbb{R}_{\max}^{n \times n}$ and \mathcal{G} a subgraph of $\mathcal{D}(A)$ with n' nodes, we have:*

$$\forall \gamma \in \mathbb{N}, T_{cr}^\gamma(\mathcal{G}) \leq \gamma n + n - n' - 1. \quad (20)$$

The next proposition can be proved using a slight generalization of [14], Proposition 6.5 (i), which differs in the fact that \mathcal{G} is considered as a whole and not each s.c.c. at a time. The proof of [14] actually shows this stronger statement.

Proposition 4.7. *Let A be a square matrix such that all s.c.c.’s of $\mathcal{G}^c(A)$, have the same girth g . Let \mathcal{G} be the subgraph of $\mathcal{G}^c(A)$ consisting of all cycles of length g . Then*

$$T_1(A) \leq T_{cr}^g(\mathcal{G}) - g + 1.$$

We are finally able to prove Proposition 4.2.

Proof of Proposition 4.2. Let us assume that $T_1(A) = \text{DM}(g, n)$. We want to prove that $\mathcal{G}^c(A)$ is strongly connected and has only one cycle with length g , up to choice of its first node.

To apply Proposition 4.7 we need to show that all s.c.c.’s of $\mathcal{G}^c(A)$ have girth g .

Otherwise, w.r.t. the notation of Proposition 4.4 let \mathcal{G}_1^c be a component with girth $g_1 < g$. We have $\text{DM}(g_1, n_1) < \text{DM}(g, n)$ (recall that $\text{DM}(g, n) = g(n - 2) + n$). For all other components of $\mathcal{G}^c(A)$ we have $\text{DM}(g_\nu, n_\nu) < \text{DM}(g, n)$ since $n_\nu < n$. Therefore using the bound of Proposition 4.4 we would have $T_1(A) < \text{DM}(g, n)$.

Now, we will combine Propositions 4.7 and 4.6 to show both the connectivity of the $\mathcal{G}^c(A)$ and the uniqueness of the shortest critical cycle. Let us denote by n' the number of nodes of the graph \mathcal{G} of Proposition 4.7 and set $\gamma = g$ in (20) (see Proposition 4.6). Then we have

$$T_1(A) \leq T_{cr}^g(\mathcal{G}) - g + 1 \leq (gn + n - n' - 1) - g + 1 = \text{DM}(g, n) + g - n'.$$

If $\mathcal{G}^c(A)$ is not strongly connected then \mathcal{G} is not and $n' \geq 2g$. If $\mathcal{G}^c(A)$ is strongly connected but contains more than one cycle, then $n' > g$. Indeed, one can not have two critical cycles of length g with the same set of nodes, because it would build a shorter cycle so that g would not be the girth anymore. Thus, in both cases, we would have $n' > g$ and $T_1(A) < \text{DM}(g, n)$.

Finally, $\mathcal{G}^c(A)$ is strongly connected and contains exactly one cycle of length g , up to choice of its first node. \square

4.4. The Interesting Walk and Its Structure

In this section we assume that $T_1(A) = \text{DM}(g, n)$. and deduce from this the structure of special walks which we call interesting.

By Proposition 4.2, there is a unique critical cycle of length g up to choice of its first node. In what follows, the subgraph consisting of all nodes and edges of this cycle will be denoted by Z_0 .

Definition 4.8. A walk $W \in \mathcal{W}^t(i \xrightarrow{Z_0} j)$ is called *twice optimal* if it has minimal length among all the walks with maximal weight in the set $\mathcal{W}^{t,g}(i \xrightarrow{Z_0} j)$. It is called *interesting* if it is twice optimal and has length $\text{DM}(g, n) + g - 1$.

Interesting walks are twice optimal with maximal possible length among all entries and matrices. Their particular structure, described in Proposition 4.11 will define matrices A_1, A_2, B_1 .

Proposition 4.9. *If $T_1(A) = \text{DM}(g, n)$, then there exists (i, j) such that $(A^{\text{DM}(g,n)-1})_{i,j} < (CS^{\text{DM}(g,n)-1}R)_{i,j}$. For any such (i, j) there is an interesting walk from i to j .*

Proof. We set $t = \text{DM}(g, n) - 1$.

If there is no (i, j) such that $(A^{\text{DM}(g,n)-1})_{i,j} < (CS^{\text{DM}(g,n)-1}R)_{i,j}$, then for all i, j we have $(A^t)_{i,j} \geq (CS^tR)_{i,j}$.

By definition of B , we have $(A^t)_{i,j} \geq (B^t)_{i,j}$ for all t, i, j . We hence have $(A^t)_{i,j} \geq (B^t)_{i,j} \oplus (CS^tR)_{i,j}$. We always have the opposite inequality $(A^t)_{i,j} \leq (B^t)_{i,j} \oplus (CS^tR)_{i,j}$ by distinguishing whether a walk visits the critical graph or not. Hence $(A^t)_{i,j} = (B^t)_{i,j} \oplus (CS^tR)_{i,j}$. But this means $T_1(A) \leq t < \text{DM}(g, n)$, which contradicts $T_1(A) = \text{DM}(g, n)$.

Let us prove the second part of the proposition.

Proposition 4.6, applied with $\mathcal{G} = Z_0$, $\gamma = g$ and $n' = g$, implies that twice optimal walks have length at most $t + g$ (alternatively, see the proof of [14] Theorem 4.1).

Now, if there is no interesting walk from i to j it means that the set $\mathcal{W}^{t,g}(i \xrightarrow{Z_0} j)$ contains a walk with optimal weight and length strictly less than $t + g$. However, this length is congruent to t modulo g , hence it is less than or equal to t and, furthermore, can be made equal to t by inserting copies of Z_0 . The weight of this walk is $(CS^{\text{DM}(g,n)-1}R)_{i,j}$ by Proposition 2.17, so $(A^{\text{DM}(g,n)-1})_{i,j} \geq (CS^{\text{DM}(g,n)-1}R)_{i,j}$. \square

Proposition 4.10. *If $n = g = 2$ and $A \in \mathbb{R}_{\max}^{2 \times 2}$, then $T_1(A) = \text{DM}(2, 2) = 2$ if and only if $a_{11} \neq a_{22}$.*

Proof. Observe that $n = g = 2$ implies that $\mathcal{G}^c(A)$ consists of the nodes and arcs of the unique cycle of length 2 up to choice of its first node, and that both nodes of $\mathcal{D}(A)$ are critical. Thus $B_N = \mathbf{0}$, $T_1(A) = T(A)$ and $T_1(A) < 2 \Leftrightarrow A^3 = A$.

Let us notice that $(a_{11})^{\otimes 2} < a_{12} \otimes a_{21} = \lambda(A) = \mathbf{1}$ and $a_{22}^{\otimes 2} < a_{12} \otimes a_{21} = \lambda(A) = \mathbf{1}$, and compute A^3 .

Consider first the off-diagonal entries. In this case we have

$$(A^3)_{k,l} = \max\{a_{k,l}a_{l,k}a_{k,l}, (a_{k,k})^2a_{k,l}, a_{k,l}(a_{l,l})^2\} = a_{k,l}$$

for any such $k, l \in \{1, 2\}$.

Consider now

$$\begin{aligned} (A^3)_{k,k} &= \max\{(a_{k,k})^3, a_{k,l}a_{l,l}a_{l,k}, a_{k,l}a_{k,k}a_{l,k}\} \\ &= \max\{a_{k,k}, a_{l,l}\}, \end{aligned}$$

for $k, l \in \{1, 2\}$ and $l \neq k$. This is not equal to $a_{k,k}$ if and only if $a_{k,k} < a_{l,l}$. Finally, $A^3 = A \Leftrightarrow a_{k,k} = \max\{a_{k,k}, a_{l,l}\} \Leftrightarrow a_{1,1} = a_{2,2}$ and the proof is complete. \square

The following proposition, to be proved in Subsection 4.5, shows uniqueness and characterizes the interesting walk in the remaining cases of g and n .

Proposition 4.11. *Let $A \in \mathbb{R}_{\max}^{n \times n}$ be such that $g = g(\mathcal{G}^c(A)) \geq 2$, $T_1(A) = \text{DM}(g, n)$, and not $n = g = 2$. For any interesting walk W_0 , there is a renumbering of the nodes such that $1, \dots, g$ are the nodes of the (only) critical cycle of length g and*

$$W_0 = (g+1) \dots n \overbrace{(1 \dots n)^g}^{g \text{ times}}, \quad (21)$$

where $(1 \dots n)^g = \overbrace{(1 \dots n)(1 \dots n) \dots (1 \dots n)}^{g \text{ times}}$.

Corollary 4.12. *Under the conditions of Proposition 4.11, $\mathcal{D}(A)$ has an Hamiltonian cycle with maximal weight, unique up to choice of its first node, which is labeled $1 \dots n1$ by the renumbering stated in Proposition 4.11.*

Proof. By contradiction, suppose that there is a different Hamiltonian cycle with the largest weight. It can replace one of the copies of $1 \dots n1$ in W_0 , and the walk should still be interesting. However as $g \geq 2$, the resulting walk contains edges of at least two different Hamiltonian cycles, so it cannot be represented as (21), which is in contradiction with this walk being interesting. \square

Remark 4.13. By Proposition 4.11 and Corollary 4.12, the Hamiltonian cycle with maximal weight induces a renumbering of the nodes, which is unique up to choice of the first node. Then, the first node is defined as the end of the only edge of Z_0 that does not belong to the Hamiltonian cycle. Thus, the renumbering is unique and so is the interesting walk.

4.5. Proof of Proposition 4.11

Let us first note that the case $g = n$ is impossible unless $n = g = 2$. Indeed, if $n = g > 2$ then $\text{DM}(g, n) = n(n-2) + n = n(n-1) > (n-1)^2 + 1$, which is the Wielandt bound for the periodicity transient, so in this case $\text{DM}(g, n)$ cannot be attained. The case $n = g = 2$ has been considered in Proposition 4.10.

The following elementary number-theoretic lemma will be especially useful in what follows.

Lemma 4.14. *Let $a_1, \dots, a_s \in \mathbb{Z}$. Then there is a nonempty subset $I \subseteq \{1, \dots, s\}$ with $\sum_{i \in I} a_i \equiv_s 0$.*

This lemma will allow us to remove some cycles from a walk and keep its length modulo s as soon as we have s cycles that do not intersect in the walk.

The first step of the proof of Proposition 4.11 is to establish properties of the structure of interesting walks.

Lemma 4.15. *In any interesting walk W_0 , there are exactly g occurrences of each node of Z_0 and exactly $g + 1$ occurrences of each node not in Z_0 .*

Proof. This is an improvement on the proof of Theorem 2.15 in [14] with extra care on the extremal cases. Let us first argue that the number of occurrences does not exceed g and $g + 1$, respectively.

By contradiction, let $l \in Z_0$ occur $k \geq g + 1$ times, then we have $W_0 = V_0 l V_1 l \dots l V_{k-1} l V_k$ where l occurs in no V_i .

We have $k - 1 \geq g$ and by Lemma 4.14 some of the cycles $l V_p l$ (for $p = 1, \dots, k - 1$) can be removed in such a way that the resulting walk has the same length modulo g . Moreover, the resulting walk still goes through a node of Z_0 (namely l) and has the same length modulo g meaning that W_0 is not twice optimal.

Let $m \notin Z_0$ and decompose $W_0 = W_1 s W_2$ so that W_1 contains only nodes not in Z_0 and $s \in Z_0$. Then we have two cases:

- a) One of the walks W_1 or W_2 does not contain m . Then the remaining walk can have no more than g occurrences of m , otherwise these occurrences lead to at least g cycles some of which can be removed in such a way that the resulting walk has the same length modulo g and goes through a node of Z_0 , contradicting the optimality of W_0 (the weight of the resulting walk is also not smaller since by $\lambda(A) = \mathbf{1}$ the weight of each cycle is not bigger than $\mathbf{1}$).
- b) Both W_1 and W_2 contain m at least once. If there are at least two occurrences of m in W_1 then the cycle between these occurrences can be moved to W_2 . Hence we can assume that W_1 contains m no more than once. As in a), m can occur in W_2 no more than g times, and the total number of m 's occurrences is thus bounded by $g + 1$.

The total number of occurrences of all nodes in W_0 is thus bounded from above by $g^2 + (n - g)(g + 1) = n - g + ng$. Observe now that the total number of these occurrences is exactly $g(n - 1) + n = n - g + ng$, since the length of W_0 is $\text{DM}(g, n) + g - 1 = g(n - 1) + n - 1$. Hence each node in Z_0 occurs exactly g times and each node not in Z_0 exactly $g + 1$ times. \square

Lemma 4.16 (Interlacing). *Let $i \in Z_0$ and $j \notin Z_0$.*

- (i) *In any interesting walk, there is exactly one occurrence of node j between two consecutive occurrences of i .*
- (ii) *In any interesting walk, there is exactly one occurrence of j before the first and exactly one after the last occurrence of i .*

Proof. We are going to prove that, for each $k: 0 \leq k < g$, there are exactly $k + 1$ occurrences of j before the $(k + 1)$ -th occurrence of i and $g - k$ occurrences of j after that occurrence of i . This implies both parts of the lemma.

We first show after $k + 1$ occurrences of i we have no more than $g - k$ occurrences of j , for otherwise we have k consecutive closed walks going

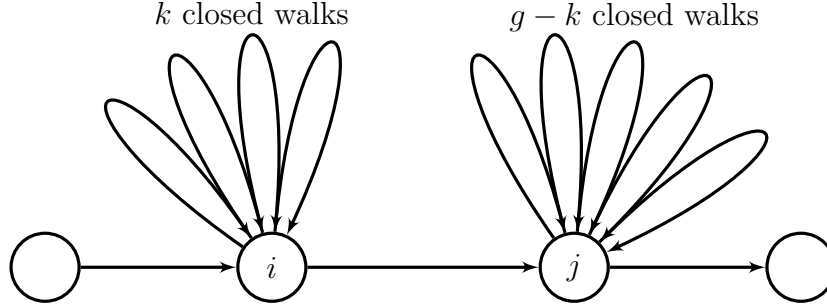

Figure 4: More than $g - k$ occurrences of j after $k + 1$ occurrences of i

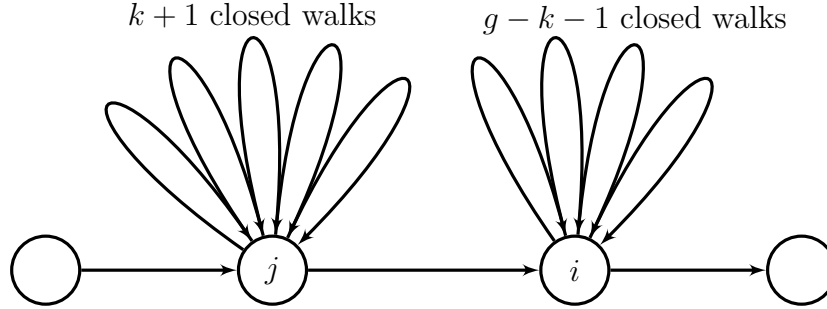

Figure 5: More than $k + 1$ occurrences of j before $(k + 1)$ -th occurrence of i

through i and at least $g - k$ consecutive closed walks going through j . Figure 4 depicts the situation. Thus the overall number of closed walks is at least g and by Lemma 4.14 some of these closed walks can be removed from the walk. The resulting walk still goes through a node of Z_0 (namely i) and has the same length modulo g , so W_0 is not twice optimal, a contradiction.

Let us also show that we have no more than $k + 1$ nodes of j before the $(k + 1)$ -th occurrence of i . Indeed, after the $(k + 1)$ -th occurrence of i we still have $g - k - 1$ occurrences of i by Lemma 4.15. If the hypothesis is not true then we have $g - k - 1$ closed walks going through i and at least $k + 1$ closed walks going through j . Figure 5 depicts the situation. Thus we have at least g closed walks in total and by Lemma 4.14 some of these closed walks can be removed from the walk. We conclude that W_0 is not twice optimal, a contradiction.

However, the total number of occurrences of j before and after the $(k + 1)$ -

th occurrence of i is $g + 1$, and therefore there are exactly $k + 1$ occurrences of j before the $(k + 1)$ -th occurrence of i , and $g - k$ occurrences of j after that occurrence. \square

Corollary 4.17. *In any interesting walk, there is exactly one occurrence of node $i \in Z_0$ between every two consecutive occurrences of $j \notin Z_0$, and no occurrences of $i \in Z_0$ neither before the first nor after the last occurrence of $j \notin Z_0$.*

Lemma 4.18. *Any interesting walk W_0 can be represented as*

$$W_0 = PQP_1V, \tag{22}$$

where P and P_1 contain all nodes not in Z_0 exactly once and only them, Q contains all nodes of Z_0 exactly once and only them, and V is a walk starting with a node in Z_0 .

Proof. Define P such that $W_0 = PV_0$, where all nodes of P are not in Z_0 and the first node of V_0 is in Z_0 . By Lemma 4.16 part (ii), P contains all nodes not in Z_0 exactly once (and only them).

Define Q as the subpath of V_0 such that $V_0 = QU_1$, where all nodes of Q are in Z_0 and the first node of U_1 is not in Z_0 . That node also occurs once in P . By Lemma 4.16 part (i), all nodes of Z_0 should occur between the two occurrences of that node exactly once, and therefore Q contains all such nodes exactly once (and only them).

Define P_1 such that $U_1 = P_1V$, where all nodes of P_1 are not in Z_0 and the first node of V is in Z_0 . That node also occurs once in Q . By Lemma 4.16 part (ii), all nodes that are not in Z_0 should occur between the two occurrences of that node exactly once, and therefore P_1 contains all such nodes exactly once (and only them). \square

Proof of Proposition 4.11. Let W_0 be an interesting walk and P and Q defined as in (22). We want to show

$$W_0 = P(QP)^g. \tag{23}$$

We start with the decomposition (22). Define $k \in Z_0$ as the last node of Q and Q' by $Q = Q'k$.

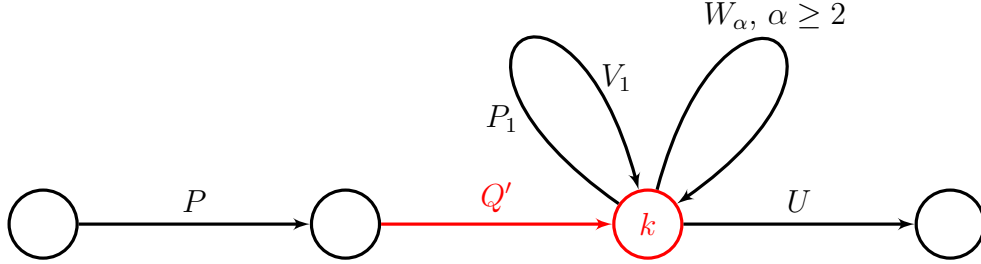

Figure 6: Structure of interesting walk W_0 as of (24)

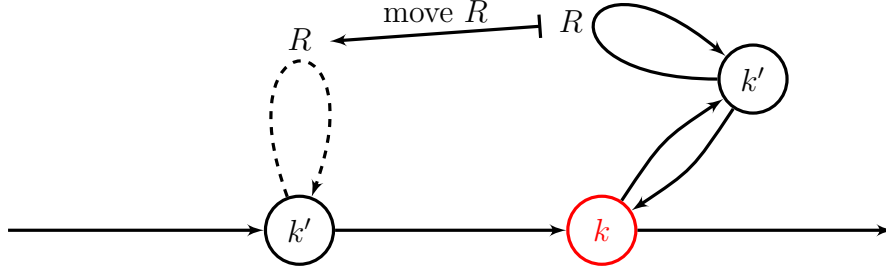

Figure 7: Node k' appears twice in $C_1 = kP_1V_1k$

As a first step, using (22) and observing g occurrences of k we can immediately obtain

$$W_0 = PQ'kW_1kW_2 \dots kW_{g-1}kU, \quad (24)$$

see Figure 6. Decomposition (22) also implies that the subpath PQ in the beginning should be followed by a sequence P_1 containing all non-critical nodes once (and only them), in any interesting walk. Therefore we have $W_1 = P_1V_1$ for some V_1 .

The cycle $C_1 = kP_1V_1k$ contains each node (critical and non-critical) no more than once. Indeed, if a node k' occurred in C_1 twice then we would decompose $C_1 = k \dots k'Rk' \dots k$, replace the node k' in PQ by $k'Rk'$ and delete Rk' from C_1 , see Figure 7. This would result in a new walk with g consecutive closed walks some of which can be removed, resulting in a walk of a smaller length and showing that the initial walk was not interesting, a contradiction.

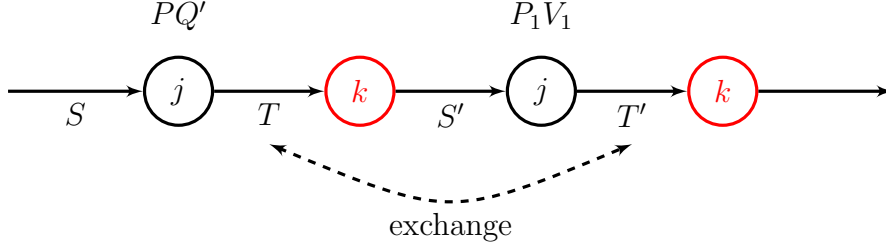

Figure 8: Exchange if $PQ' \neq P_1V_1$

Since any node is contained in C_1 no more than once, V_1 consists of nodes of Z_0 only. Comparing (23) with (24) we need to prove that $V_1 = Q'$ and that $P_1 = P$. For that, take any node $j \in P_1V_1$. It also occurs in PQ' since that path contains all nodes but k . Consider the following decompositions $PQ'k = S_jTk$ and $P_1V_1k = S'jT'k$. If we assume that $Q' \neq V_1$ or $P_1 \neq P$ then for some j the sets of nodes of S and S' differ or the sets of nodes of T and T' differ. Assume the latter (the case of different S and S' is treated similarly). By replacing $PQ'k$ with $S_jT'k$ and P_1V_1k by $S'jTk$ as in Figure 8 (in other words, by exchanging T and T') we obtain a new interesting walk. We now prove that it is not of the form (22), in contradiction with Lemma 4.18.

Indeed, we have $S_jT'k = \tilde{P}\tilde{Q}$ where \tilde{P} consists only of nodes not in Z_0 , and \tilde{Q} consists only of nodes in Z_0 . Similarly, $S'jTk = \tilde{P}_1\tilde{Q}_1$ where \tilde{P}_1 consists only of nodes not in Z_0 , and \tilde{Q}_1 consists only of nodes in Z_0 . However, the set of nodes of $T'k$ is a complement of the set of nodes of S_j (recall that $PQ'k = S_jTk$ and all nodes occur in PQ exactly once) and that of $T'k$ is not (since T and T' have different node sets), and this implies that \tilde{P} or \tilde{Q} miss some nodes in contradiction with Lemma 4.18. Hence $P_1 = P$ and $V_1 = Q'$.

Generalizing the cycle C_1 , define $C_\alpha = kW_\alpha k$ for all $1 \leq \alpha \leq g-1$. Since we can exchange any two C_α without changing neither the length, nor the weight of the walk, the decomposition of C_1 is also true for any C_α , that is $C_\alpha = kPQ'k$ for all α .

Now, each critical node occurs in the walk $PQ'kW_1kW_2 \dots kW_{g-1}k = (PQ)^g$ exactly g times, hence, by Lemma 4.16 part (ii), U contains all non-critical nodes exactly once, and only them. So we have obtained that $W_0 = (PQ)^gU$ where U contains all non-critical nodes exactly once, and only them.

It remains to show that $U = P$. In $\mathcal{D}(A^T)$ (the graph of the transpose

of A) there is also an interesting walk. Since $(A^T)^m = (A^m)^T$ for all $m \geq 1$, Walk W_0^T , that starts with the end of W_0 and goes to the beginning of W_0 via exactly the same nodes listed in the opposite order is an interesting walk on $\mathcal{D}(A^T)$. On one hand, by construction $W_0^T = U^T(Q^T P^T)^g$, where U^T , Q^T and P^T contain the same nodes as U , Q and P listed in the opposite order. On the other hand, applying the argument above we get a decomposition of the form $W_0^T = (\overline{P} \overline{Q})^g \overline{U}$, and, since $g \geq 2$, we conclude that $U^T = P^T = \overline{P}$. This implies $U = P$, so the decomposition (23) is established.

In order to obtain (21) we renumber the nodes of $\mathcal{D}(A)$ in such a way that $QP = 1 \dots n$. \square

Corollary 4.19. *If $T_1(A) = \text{DM}(g, n)$ then n and g are coprime (Condition 1).*

Proof. If n and g are not coprime, then $d = \text{gcd}(n, g) > 1$. We have $g = pd$ and $n = qd$ for some p and q . Let W_0 be given by (21) and W_1 be $(g+1) \dots n(1 \dots n)^{g-p}$. Since $pn = gq$, we have $l(W_1)$ and $l(W_0)$ are congruent modulo g , and since $p(W_1) \geq p(W_0)$, we obtain that W_0 is not twice optimal, so $T_1(A, B) < \text{DM}(g, n)$ by Proposition 4.11, a contradiction. \square

4.6. Proof of Necessity

In this subsection, we finish the proof of necessity of Conditions 1.–6. and the last statement of the theorem. We assume $T_1(A) = \text{DM}(g, n)$.

Condition 1 was proved as Corollary 4.19. By Proposition 4.2, $\mathcal{G}^c(A)$ is strongly connected and contains only one cycle with length g denoted by Z_0 . (Condition 2).

We now turn to the proof of Conditions 3, 4, and 5, which will be proved together. The core of the proof is split into Lemmas 4.20, 4.21 and 4.22 below.

By Proposition 4.11 there is a unique twice optimal walk W_0 of length $\text{DM}(g, n) + g - 1$. After renumbering the nodes we can assume that $(i, i + 1)$ for $1 \leq i \leq (n - 1)$ and $(n, 1)$ are the arcs of a Hamiltonian cycle of $\mathcal{D}(A)$, and that nodes $\{1, \dots, g\}$, are the nodes of Z_0 .

Notice that we have not yet proved $Z_0 = 1 \dots g1$ (condition 3) since we do not know the arcs of Z_0 .

Any occurrence of a node in W_0 can be encoded by its *position* in that walk. We now define what we mean by position. We assume that the first occurrence of node n has position 0, and the position of any node i in the k th

copy of $1 \dots n$ (called *period*) is $i + (k - 1)n$, and the position of the i th node in the part of the walk before the first occurrence of 1 (for $i \in \{g + 1, \dots, n\}$) is $i - n$. Note that these positions (and only these) are non-positive.

We will be interested in the set of subwalks of W_0 from i to j , with length 1 modulo g . Denote this set by $\mathcal{W}^{1,g}(i \rightarrow j)[W_0]$. This set is nonempty if and only if there is an occurrence of node i at some position denoted by N_i^b and there is an occurrence of node j at some position denoted by N_j^e such that $N_j^e > N_i^b$ and $N_j^e - N_i^b \equiv_g 1$.

Consider the following properties of subwalks of W_0 :

Property A: We say that a subwalk $W \in \mathcal{W}^{1,g}(i \rightarrow j)[W_0]$ has this property if it goes through one of the first g nodes (i.e. a node of Z_0).

Property B: We say that a subwalk $W \in \mathcal{W}^{1,g}(i \rightarrow j)[W_0]$ has this property if after replacing W in W_0 by the arc (i, j) where i and j are the beginning node and the end node of W respectively, the resulting walk W'_0 goes through one of the first g nodes.

A subwalk $W \in \mathcal{W}^{1,g}(i \rightarrow j)[W_0]$ does not have Property B if and only if it begins at a non-positive position, ends in the last period of W_0 and has $i, j > g$.

Define A_1 , B_1 and A_2 by (10), (11) and (12).

Lemma 4.20. *If $W \in \mathcal{W}^{1,g}(i \rightarrow j)[W_0]$ has Property A then $p(W) \leq (CSR)_{i,j}[A]$.*

Proof. Property A means that W belongs to $\mathcal{W}^{1,g}(i \xrightarrow{Z_0} j)$ on $\mathcal{D}(A)$, since the first g nodes are the node set of Z_0 . As $(CSR)_{i,j}[A]$ is the largest weight of walks in $\mathcal{W}^{1,g}(i \xrightarrow{Z_0} j)$ on $\mathcal{D}(A)$ (recall $\lambda(A) = \mathbf{1}$ and Proposition 2.16 part (i)), the claim follows. \square

Lemma 4.21. *If $W \in \mathcal{W}^{1,g}(i \rightarrow j)[W_0]$ has Property B and $j \neq i + 1$ and $(i, j) \neq (n, 1)$ then $a_{i,j} < p(W)$.*

Proof. If $a_{i,j} \geq p(W)$ then replacing W by (i, j) in W_0 we get a walk with the same length modulo g as W_0 , whose weight is not less than $p(W_0)$ and whose length is strictly less than $\ell(W_0)$. This contradicts the fact that W_0 is twice optimal. \square

Lemma 4.22. *1. If $j \not\equiv_g (i + 1)$ then $a_{i,j} < (CSR)_{i,j}[A_1]$ and $a_{i,j} < (CSR)_{i,j}[A_1 \oplus B_1]$;*

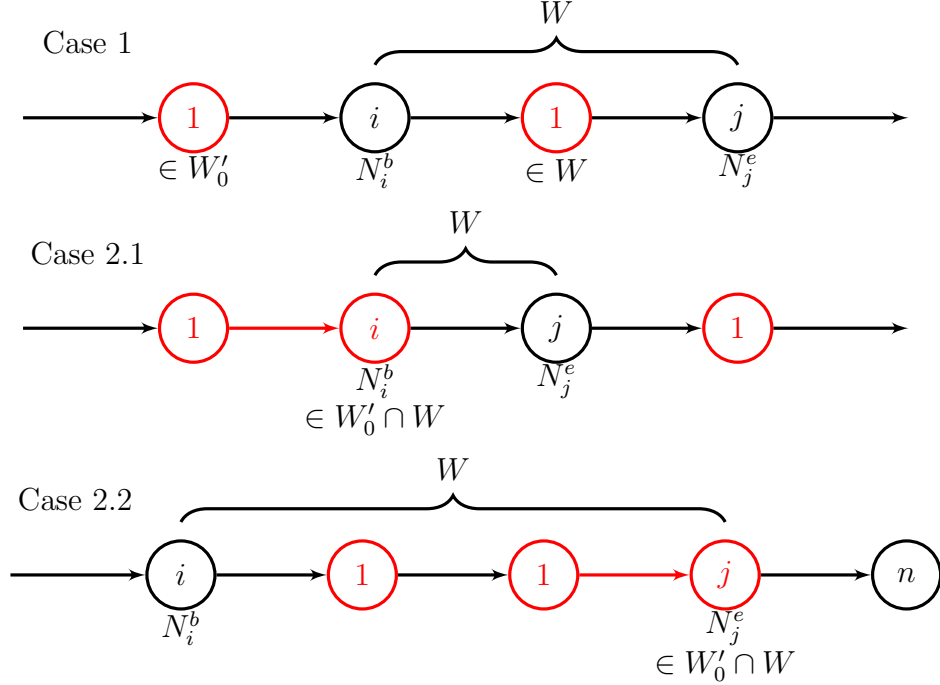

Figure 9: Cases 1, 2.1, and 2.2

2. If $j \equiv_g (i + 1)$ and i or j belong to $\{1, \dots, g\}$ but $j \neq i + 1$ and $(i, j) \neq (g, 1)$, then $a_{i,j} < (CSR)_{i,j}[A_1]$ and $a_{i,j} < (CSR)_{i,j}[A_1 \oplus B_1]$;
3. The arcs $(i, i + 1)$ for $1 \leq i \leq g - 1$ and $(g, 1)$ are critical.

Proof. We will examine the existence of walks with Properties A and B in the cases of our interest, and apply Lemmas 4.20 and 4.21 .

1: Examine the case $j \not\equiv_g (i + 1)$. We take the occurrence of i in the first period, that is, $N_i^b = i$. Then, since $j \not\equiv_g (i + 1)$, the (unique) occurrence of j for which $N_j^e - i \equiv_g 1$ and $N_j^e > i$ exists in some other period. They have both Property A and Property B, and Lemmas 4.20 and 4.21 imply that $a_{i,j} < (CSR)_{i,j}[A]$. See Figure 9 for this case as well as cases 2.1 and 2.2 described below.

2: We need to examine the following two cases: 2.1 $j \equiv_g (i + 1)$, $j > i$ and $i \leq g$ and 2.2 $j \equiv_g (i + 1)$, $j < i$, $i > g$, $j \leq g$.

Case 2.1. We can take the occurrences of i and j in any period k at positions $N_i^b = i + (k - 1)n$ and $N_j^e = j + (k - 1)n$.

Case 2.2. Take the occurrence of i with $N_i^b = i - n$ and the occurrence of j with $N_j^c = j + (g - 1)n$ (in the last period).

In both cases, the walks defined by these occurrences have both Property A and Property B. By Lemmas 4.20 and 4.21, we have $a_{i,j} < (CSR)_{i,j}[A]$ if $j \neq i + 1$. Note that here and in 1. above we still have to argue that A can be replaced with A_1 and $A_1 \oplus B_1$.

3: If an arc (i, j) is critical then $a_{i,j} = (CSR)_{i,j}[A]$. Hence if $a_{i,j} < (CSR)_{i,j}[A]$ then (i, j) is non-critical. As $\{1, \dots, g\}$ are nodes of a critical cycle of length g and parts 1. and 2. above imply that $(i, i + 1)$ for $1 \leq i \leq g - 1$ and $(g, 1)$ are the only arcs between the first g nodes that can have $a_{i,j} = (CSR)_{i,j}[A]$, so these arcs are critical.

Thus $1 \dots g1$ is a critical cycle of A and $\lambda(A_1) = \lambda(A_1 \oplus B_1) = \mathbf{1}$, and therefore A can be replaced with A_1 and $A_1 \oplus B_1$ first in statement and proof of Lemma 4.20 and therefore also in the proofs of 1. and 2. above. \square

Condition 3 of the theorem follows now from Lemma 4.22 3., Condition 4 follows from Lemma 4.22 2., and Condition 5 is implied by the following Lemma.

Lemma 4.23. *If $j \equiv_g (i + 1)$ and $j > i > g$ then $a_{i,j} < (A_1)_{i,j}^{j-i}$.*

Proof. We can take the occurrences of i and j at positions $i - n$ and $j - n$. The resulting walk has Property B. Hence by Lemma 4.21 we have $a_{i,j} < p(W)$ for $j \neq i + 1$. As W is also a unique (and hence optimal) walk on $\mathcal{D}(A_1)$ from i to j and having length $j - i$ we obtain that $p(W) = (A_1)_{i,j}^{j-i}$. \square

It remains to obtain Condition 6. Since $T_1(A) = \text{DM}(g, n)$, we have $(A^{\text{DM}(g,n)-1})_{g+1,n} < (CS^{\text{DM}(g,n)-1}R)_{g+1,n}[A]$, and hence $(B_1^{\text{DM}(g,n)-1})_{g+1,n} < (CS^{\text{DM}(g,n)-1}R)_{g+1,n}[A]$.

Let us argue that $CS^t R[A] = CS^t R[A_1]$ for all t . Indeed, the equality $CS^t R[A] = CS^t R[A_1 \oplus B_1]$ follows from Lemma 3.11 since $A_2 < CSR[A_1 \oplus B_1]$ by Lemma 4.22, and the equality $CS^t R[A_1 \oplus B_1] = CS^t R[A_1]$, follows from Lemma 4.1. We also have $CS^{\text{DM}(g,n)-1} R[A_1] = CS^{n-1} R[A_1]$ since $\lambda(A_1) = \mathbf{1}$ and $\text{DM}(g, n) \equiv_g n$.

The remaining uniqueness statements have been proved in Remark 4.13.

5. Matrices Attaining the Wielandt Bound

This section is devoted to the proof of Theorem 3.7.

If $\text{Wi}(n) > \text{DM}(g, n)$, then the Wielandt bound cannot be attained. Hence we are only interested in the case when $\text{Wi}(n) \leq \text{DM}(g, n)$. Observe that $\text{Wi}(n) = \text{DM}(n - 1, n)$, and therefore

$$\text{DM}(g, n) \geq \text{Wi}(n) \Leftrightarrow \text{DM}(g, n) \geq \text{DM}(n - 1, n) \Leftrightarrow g \geq n - 1$$

for any $n \geq 2$.

Thus we have two cases: $g = n - 1$ and $g = n$.

In case $g = n - 1$, we have $\text{DM}(n - 1, n) = \text{Wi}(n)$, and observe that Conditions 1, 5 and 6 of Theorem 3.1 trivially hold, in view of Remark 3.3. Next, both sufficiency and necessity as well as the last part of the statement, for $g = n - 1$, follow as a special case of the corresponding claims in Theorem 3.1.

In case $g = n$, let us prove the sufficiency and necessity of Condition 2.

Sufficiency: By Lemma 3.11, Condition 2 implies that $T_1(A) = T_1(A_1)$, so it suffices to show that $T_1(A_1) = \text{Wi}(n)$. For this, note that for \tilde{A}_1 with entries defined by

$$(\tilde{A}_1)_{i,j} = \begin{cases} \mathbf{1}, & \text{if } (A_1)_{i,j} \neq \mathbf{0}, \\ \mathbf{0}, & \text{otherwise.} \end{cases} \quad (25)$$

(Wielandt's example, see e.g. [5]) we have $T(\tilde{A}_1) = \text{Wi}(n)$, meaning that there exist i, j such that $(\tilde{A}_1)_{i,j}^{\text{Wi}(n)-1} = \mathbf{0}$. This implies that also $(A_1)_{i,j}^{\text{Wi}(n)-1} = \mathbf{0}$ and hence $T_1(A_1) \geq \text{Wi}(n)$ (recalling that $T_1(A_1) = T(A_1)$). However we also have $T_1(A_1) \leq \text{Wi}(n)$ and hence $T_1(A_1) = \text{Wi}(n)$.

Necessity: To prove necessity we will need the following result, which is analogous to Proposition 4.11. Since the conditions are invariant under scalar multiplication, we will assume $\lambda(A) = \mathbf{1}$ in the rest of this section.

Proposition 5.1. *Let $A \in \mathbb{R}_{\max}^{n \times n}$ for $n \geq 1$ and $g = n$. If A has $T_1(A) = \text{Wi}(n)$, then there exists a unique twice optimal walk of length $\text{Wi}(n) + n - 1$. It is of the form*

$$W_0 = n(1 \dots (n - 1))^{n-1} 1 \dots n, \quad (26)$$

where, after appropriate renumbering, $(i, i + 1)$ for $1 \leq i < n$ and $(n, 1)$ are the arcs of the unique critical cycle.

Proof. This is an improvement on the proof of Theorem 2.15 in [14] with extra care on the extremal cases.

Let Z_0 be a critical cycle, which is of length n . This is the only critical cycle (up to choice of its first node) as any extra arc would lead to a shorter cycle.

Let W be a twice optimal walk. Denote its first node by i and its last node by j . Let $i_\alpha j_\alpha$, for $\alpha = 1, \dots, m$ be the noncritical arcs of W . For every such arc of W , insert a copy of Z_0 as a walk beginning and ending at j_α . Denote the resulting walk by W' . Observe that for each noncritical arc $i_\alpha j_\alpha$ we can detect the node i_α occurring in the subsequent copy of Z_0 . This gives rise to a cycle C_α consisting of a shortcut $i_\alpha j_\alpha$ and a number of critical arcs. Thus we obtain the following decomposition in term of the multiset of its arcs:

$$M(W') = M(P) \cup \bigcup_{\alpha=1}^m M(C_\alpha) \cup \bigcup_{\beta=1}^k M(Z_\beta) ,$$

where $M(V)$ denotes the multiset of arcs of a walk V , m is the number of noncritical arcs in the original walk, the Z_β are critical cycles, and P is a critical path from i to j . Since Z_0 is the only critical cycle, we have $Z_\beta = Z_0$ for all β . We can remove $k - 1$ copies of Z_0 and get an optimal walk in $\mathcal{W}^{1,n}(i \rightarrow j)$ of smaller length. Denote the resulting walk by W'' .

Further, since W'' has the largest weight in $\mathcal{W}^{1,n}(i \rightarrow j)$, one cannot remove cycles from it maintaining the length modulo n , and hence $m \leq n - 1$ by Lemma 4.14. We distinguish two cases:

1) $M(P) \cup \bigcup_{\alpha=1}^m M(C_\alpha)$ is connected, in which case also the k^{th} copy of Z_0 can be removed. The length of the resulting walk is bounded by $(n - 1) + (n - 1)^2 < (n - 1)^2 + n$. Thus, $T_1(A) < \text{Wi}(n)$, a contradiction, which shows that this case is impossible.

2) $M(P) \cup \bigcup_{\alpha=1}^m M(C_\alpha)$ is disconnected. Then we cannot remove Z_0 from W'' . However, in this case there is a cycle \hat{C} such that $l(\hat{C}) + l(P) \leq n - 1$. Therefore the length of W'' is bounded by $n + (n - 1) + (n - 2)(n - 1) = (n - 1)^2 + n$.

Further, in case 2, the length of all cycles C_α is bounded by $n - 2$, unless one of the connected components of $M(P) \cup \bigcup_{\alpha=1}^m M(C_\alpha)$ has size 1. In the former case the length is bounded by $n + (n - 1) + (n - 2)^2 < (n - 1)^2 + n$, which is again impossible. It thus remains to treat two subcases:

- 2a) There is a loop (or possibly, several copies of the same loop) disconnected from P , and the rest of the cycles of $M(P) \cup \bigcup_{\alpha=1}^m M(C_\alpha)$ connected to P ;
- 2b) $l(P) = 0$ and there are $n - 1$ cycles of length at most $n - 1$ disconnected from P .

In subcase 2a, the length of all cycles is bounded by $n - 2$, since any cycle of length $n - 1$ could be combined with the loop and removed. In this case, the length of the walk is again bounded by $n + (n - 1) + (n - 2)^2 < (n - 1)^2 + n$, which is impossible.

In subcase 2b, we have $i = j$. Length $l(W'')$ can reach the length $(n - 1)^2 + n$ only if all cycles C_α , not containing $i = j$, are of length $n - 1$. However, by construction, every such cycle should contain just one noncritical arc, and this has to be a 1-shortcut bypassing $i = j$. However, there is only one 1-shortcut bypassing $i = j$ which implies that all these cycles are identical and W'' has to be of the form (26), after renumbering the nodes in such a way that $Z_0 = 1 \dots n1$ and $i = n$. \square

As in the proof of Theorem 3.1, any occurrence of a node in W_0 of Proposition 5.1 can be encoded by its *position* in that walk. Node n occurs there only twice. Its first occurrence has position 0, and its second occurrence has position $(n - 1)^2 + n$. The k th occurrence of node i , for $1 \leq i \leq n - 1$ and $k = 1, \dots, n$ has position $i + (k - 1)(n - 1)$.

A subwalk of length 1 modulo n from an occurrence of node i at position N_i^b to an occurrence of node j at position N_j^e exists if and only if $N_i^b < N_j^e$ and $N_j^e - N_i^b \equiv_n 1$.

We will need the following observation:

Lemma 5.2. *If there are occurrences N_i^b of node i and N_j^e of node j such that the subwalk from N_i^b to N_j^e has length 1 modulo n and $N_j^e - N_i^b > 1$, then $a_{i,j} < (CSR[A_1])_{i,j}$.*

Proof. Denote by W the subwalk from N_i^b to N_j^e . This subwalk uses only the arcs of the digraph $\mathcal{D}(A_1)$, where it is optimal among the walks with the same length modulo n , and goes through critical nodes (since all nodes are critical). Hence $p(W) = (CSR[A_1])_{i,j}$. If W is replaced with (i, j) then the resulting walk also goes through the critical nodes, and therefore we must have $a_{i,j} < p(W)$, for otherwise W_0 is not twice optimal. Hence the claim. \square

Using Lemma 5.2, for the necessity of Condition 2, it suffices to prove that the subwalks with length 1 modulo n but larger than 1 exist for any (i, j) except possibly for $(i, j) = (n - 1, 1)$, $(i, j) = (n, 1)$, or $j = i + 1$ and $i \in \{1, \dots, n - 1\}$, which are the arcs of $\mathcal{D}(A_1)$.

Case 1. $i = j = n$. We have two occurrences of n with $N_n^b = 0$ and $N_n^e = (n - 1)^2 + n$. As $(n - 1)^2 + n \equiv_n 1$, the walk with required properties exists.

Case 2. $i = n$ and $j \neq n$. In this case $N_n^b = 0$ and we can choose $N_j^e = j + (k - 1)(n - 1)$ with $N_j^e \equiv_n 1$, since $k \in \{1, \dots, n\}$ and $n - 1$ and n are coprime.

Case 3. $i \neq n$ and $j = n$. This case is symmetrical to case 2.

Case 4. $i \neq n$, $j \neq n$, $(i, j) \neq (n - 1, 1)$, and $j \neq i + 1$. Observe that $j \neq i + 1$ is equivalent to $j \not\equiv_n (i + 1)$ because $1 \leq i \leq j \leq n$.

Take $N_b^i = i$ and $N_e^j = j + (k - 1)(n - 1)$ where $k \in \{1, \dots, n\}$. Then $N_e^j - N_b^i = (j - i) + (k - 1)(n - 1)$. As n and $n - 1$ are coprime, there is a $k \in \{1, \dots, n\}$ such that $(j - i) + (k - 1)(n - 1) \equiv_n 1$, and since $j \not\equiv_n i + 1$ we have $k > 1$ and hence $N_e^j - N_b^i > 1$. The case $N_e^j - N_b^i = 1$ is only possible if $i = (n - 1)$ and $j = 1$, the case which was excluded.

The uniqueness of the renumbering follows from the uniqueness of W_0 .

6. Matrices with Critical Columns Attaining the Bounds

This section is devoted to the proof of Theorems 3.6 and 3.10. As before, we assume that $\lambda(A) = \mathbf{1}$.

Let us first notice that the transient of critical rows and columns is at most $T_1(A)$ because if i or j is critical then $(CS^tR \oplus B_N^t)_{i,j} = (CS^tR)_{i,j}$. Thus, if the transient of a critical row or column reaches the bound, so does $T_1(A)$ and A belongs to the class defined by Theorem 3.1 (except if $g(\mathcal{G}^c(A)) = 1$) or 3.7.

Proof of Theorem 3.6. Let A be a matrix with $g(\mathcal{G}^c(A)) = g$ and a critical row i_0 whose transient is $\text{DM}(g, n)$ and show that the index of $\mathcal{G}^c(A)$ is $\text{DM}(g, n)$. Then, the same is true for a critical column by transposition of the matrix and the converse of the theorem follows from [15][Lemma 8.2]. We also have $T_1(A) = \text{DM}(g, n)$, by the above argument.

We assume without loss of generality that A is strictly visualized.

By Proposition 4.2, $\mathcal{G}^c(A)$ is strongly connected and contains a unique (up to choice of the starting node) cycle of length g denoted by Z_0 .

Since i_0 is critical, the transient of row i_0 reaches the bound means that there is a j_0 such that $A_{i_0 j_0}^{\text{DM}(g, n)-1} < (CS^{n-1}R)_{i_0 j_0}$ and by Proposition 4.9, there is an interesting walk W_0 from i_0 to j_0 .

If $g \geq 2$, then A satisfies the conditions of Theorem 3.1. We assume without loss of generality that A has been reordered as in the theorem.

By Proposition 4.11, we have $(i_0, j_0) = (g + 1, n)$, so that $g + 1$ is critical.

It remains to understand $\mathcal{G}^c(A)$. By Lemma 3.11, it is contained in $\mathcal{G}^c(A_1 \oplus B_1)$. Since A is visualized, Condition 5 ensures that it only contains entries of A_1 and entries ij with $g < j < i$, so that the only possible critical cycle that would share a node with $Z_0 = 1 \cdots g1$ is $Z_1 = 1 \cdots n1$. Finally, since $\mathcal{G}^c(A)$ is strongly connected and contains $g + 1$ and Z_0 , Z_1 is critical and we have $\mathcal{D}(A_1) \subset \mathcal{G}^c(A)$. Since g and n are coprime, $\gamma(\mathcal{G}^c(A)) = 1$.

If $g = 1$, since i_0 and Z_0 are critical, and $\mathcal{G}^c(A)$ is strongly connected, there is a walk from i_0 to any node of Z_0 with only critical arcs. Since A is strictly visualized, this walk has weight 0 and by optimality of W_0 , W_0 also uses only critical arcs from i_0 to Z_0 . But, by Lemma 4.16, W_0 goes through every node not in Z_0 before reaching Z_0 , so that all nodes are critical.

In both cases, $\mathcal{G}^c(A)$ is strongly connected, has cyclicity 1 and contains all nodes. Thus, the strict visualization ensures that $(CS^tR)_{i,j} = \mathbf{1}$ for all i, j , and that $A_{i,j} = \mathbf{1}$ if and only if (i, j) is a critical arc. Therefore, we can redefine A_1 and A_2 by $(A_1)_{i,j} = A_{i,j} = \mathbf{1}$ and $(A_2)_{i,j} = \mathbf{0}$ if (i, j) is critical and $(A_2)_{i,j} = A_{i,j} < \mathbf{1}$ and $(A_1)_{i,j} = \mathbf{0}$ otherwise. We have $A = A_1 \oplus A_2$, $\lambda(A_1) = \mathbf{1}$ and $A_2 < CSR[A_1]$, so that Lemma 3.11 ensures that the index of $\mathcal{G}^c(A)$ is $T(A_1) = T_1(A_1) = T_1(A) = DM(g, n)$. □

Proof of Theorem 3.10. Let us first check that the conditions are sufficient : $T_1(A) = T_1(A_1)$ by Lemma 3.11 and $T_1(A_1)$ is at least the index of $\mathcal{D}(A_1)$ and thus $T_1(A) = \text{Wi}(n)$. But, since all nodes are critical (because of the Hamiltonian critical cycle), this means that there is a (critical) row (or column) whose transient is $\text{Wi}(n)$.

Conversely, let us assume there is a critical row (or column) whose transient is $\text{Wi}(n)$. Since $T_1(A) = \text{Wi}(n)$ the existence of A_1 and A_2 with $A_2 < CSR[A_1]$ follows from Theorem 3.7 and we already noticed that $\mathcal{D}(A_1)$ has index $\text{Wi}(n)$. It remains to show the existence of the Hamiltonian cycle. By Lemma 3.11, we know that $\mathcal{G}^c(A) = \mathcal{G}^c(A_1)$, so that $g = g(\mathcal{G}^c(A)) \in \{n - 1, n\}$.

If $g = n - 1$, then $DM(g, n) = \text{Wi}(n)$ and we are in the situation of Theorem 3.6. Thus, $\mathcal{G}^c(A_1) = \mathcal{G}^c(A)$ has index $\text{Wi}(n)$, which is only possible if $\mathcal{G}^c(A) = \mathcal{D}(A_1)$, that is if A_1 has a critical Hamiltonian cycle.

If $g = n$, then there is an Hamiltonian cycle in $\mathcal{G}^c(A)$, which is necessarily a critical Hamiltonian cycle of $\mathcal{D}(A_1)$ because $\mathcal{G}^c(A_1) = \mathcal{G}^c(A)$. □

Acknowledgement

We are grateful to Stéphane Gaubert and anonymous referees of the paper for many constructive and helpful suggestions and comments.

- [1] Marianne Akian, Stéphane Gaubert, and Cormac Walsh. Discrete max-plus spectral theory. *Idempotent Mathematics and Mathematical Physics* (G.L. Litvinov and V.P. Maslov, eds.), Contemporary Mathematics, vol. 377, AMS, Providence, 2005, pp. 53–77.
- [2] François Baccelli, Guy Cohen, Geert Jan Olsder, and Jean-Pierre Quadrat. *Synchronization and Linearity: An Algebra for Discrete Event Systems*. Wiley, Chichester, 1992.
- [3] François Baccelli and Dohy Hong. TCP is max-plus linear and what it tells us on its throughput. *Proceedings of the Conference on Applications, Technologies, Architectures, and Protocols for Computer Communication (SIGCOMM 2000)*. ACM, New York, 2000, pp. 219–230.
- [4] Anne Bouillard and Bruno Gaujal, Coupling time of a (max,plus) matrix. *Proceedings of the Workshop on Max-Plus Algebra at the 1st IFAC Symposium on System Structure and Control*. Elsevier, Amsterdam, 2001, pp. 335–400.
- [5] Richard A. Brualdi and Herbert J. Ryser. *Combinatorial Matrix Theory*. Cambridge University Press 1991.
- [6] Peter Butkovič. *Max-linear Systems: Theory and Algorithms*. Springer, London, 2010.
- [7] Bernadette Charron-Bost, Matthias Függer, and Thomas Nowak. New transience bounds for max-plus linear systems. *Discrete Applied Mathematics* 219:83–99, 2017.
- [8] Bernadette Charron-Bost, Matthias Függer, Jennifer L. Welch, and Josef Widder. Time complexity of link reversal routing. *ACM Transactions on Algorithms* 11(3):18, 2015.
- [9] Guy Cohen, Didier Dubois, Jean-Pierre Quadrat, and Michel Viot, *Analyse du comportement périodique de systèmes de production par la théorie des dioïdes*, INRIA, Rapport de Recherche no. 191, Le Chesnay, 1983.

- [10] Guy Cohen, Pierre Moller, Jean-Pierre Quadrat, and Michel Viot. Algebraic tools for the performance evaluation of discrete event systems. *Proceedings of the IEEE* 77(1):39–85, 1989.
- [11] Anthony L. Dulmage and Nathan S. Mendelsohn. Gaps in the exponent set of primitive matrices. *Illinois Journal of Mathematics* 8(4):642–656, 1964.
- [12] S. Even and S. Rajsbaum. The use of a synchronizer yields the maximum computation rate in distributed networks. *Theory of Computing Systems* 30:447–474, 1997.
- [13] Mark Hartmann and Cristina Arguelles. Transience bounds for long walks. *Mathematics of Operations Research* 24(2):414–439, 1999.
- [14] Glenn Merlet, Thomas Nowak, and Sergeĭ Sergeev. Weak CSR expansions and transience bounds in max-plus algebra. *Linear Algebra and Its Applications* 461:163–199, 2014.
- [15] Glenn Merlet, Thomas Nowak, Sergeĭ Sergeev, and Hans Schneider. Generalizations of bounds on the index of convergence to weighted digraphs. *Discrete Applied Mathematics* 178:121–134, 2014.
- [16] Monika Molnárová. Computational complexity of Nachtigall’s representation. *Optimization* 52:93–104, 2003.
- [17] Karl Nachtigall. Powers of matrices over an extremal algebra with applications to periodic graphs. *Mathematical Methods of Operations Research* 46:87–102, 1997.
- [18] Hans Schneider, Michael H. Schneider, Max-balancing weighted directed graphs and matrix scaling, *Mathematics of Operations Research* 16:208–222, 1991.
- [19] Sergeĭ Sergeev. Max algebraic powers of irreducible matrices in the periodic regime: An application of cyclic classes. *Linear Algebra and Its Applications*:431(6):1325–1339, 2009.
- [20] Sergeĭ Sergeev and Hans Schneider. CSR expansions of matrix powers in max algebra. *Transactions of the AMS* 364:5969–5994, 2012.

- [21] Jia-yu Shao. On the exponent of a primitive digraph. *Linear Algebra and Its Applications* 64:21–31, 1985.
- [22] Gerardo Soto y Koelemeijer. *On the behaviour of classes of min-max-plus systems*. Ph.D. thesis, Delft University of Technology, 2003.
- [23] Helmut Wielandt. Unzerlegbare, nicht negative Matrizen. *Mathematische Zeitschrift* 52(1):642–645, 1950.