

## Model identification and reduction for the control of an ice cream crystallization process

Casenave, Céline; Dochain, Denis; Alvarez, Graciela; Arellano-Salazar, Marcela; Benkhelifa, Hayat; Leducq, Denis

DOI:

[10.1016/j.ces.2014.08.030](https://doi.org/10.1016/j.ces.2014.08.030)

License:

Other (please specify with Rights Statement)

*Document Version*

Peer reviewed version

*Citation for published version (Harvard):*

Casenave, C, Dochain, D, Alvarez, G, Arellano-Salazar, M, Benkhelifa, H & Leducq, D 2014, 'Model identification and reduction for the control of an ice cream crystallization process', *Chemical Engineering Science*, vol. 119, pp. 274-287. <https://doi.org/10.1016/j.ces.2014.08.030>

[Link to publication on Research at Birmingham portal](#)

### **Publisher Rights Statement:**

NOTICE: this is the author's version of a work that was accepted for publication in Chemical Engineering Science. Changes resulting from the publishing process, such as peer review, editing, corrections, structural formatting, and other quality control mechanisms may not be reflected in this document. Changes may have been made to this work since it was submitted for publication. A definitive version was subsequently published in Chemical Engineering Science, Volume 119, 8 November 2014, Pages 274–287, DOI 10.1016/j.ces.2014.08.030.

Checked for repository 27/10/2014

### **General rights**

Unless a licence is specified above, all rights (including copyright and moral rights) in this document are retained by the authors and/or the copyright holders. The express permission of the copyright holder must be obtained for any use of this material other than for purposes permitted by law.

- Users may freely distribute the URL that is used to identify this publication.
- Users may download and/or print one copy of the publication from the University of Birmingham research portal for the purpose of private study or non-commercial research.
- User may use extracts from the document in line with the concept of 'fair dealing' under the Copyright, Designs and Patents Act 1988 (?)
- Users may not further distribute the material nor use it for the purposes of commercial gain.

Where a licence is displayed above, please note the terms and conditions of the licence govern your use of this document.

When citing, please reference the published version.

### **Take down policy**

While the University of Birmingham exercises care and attention in making items available there are rare occasions when an item has been uploaded in error or has been deemed to be commercially or otherwise sensitive.

If you believe that this is the case for this document, please contact [UBIRA@lists.bham.ac.uk](mailto:UBIRA@lists.bham.ac.uk) providing details and we will remove access to the work immediately and investigate.

# Author's Accepted Manuscript

Model identification and reduction for the control of an ice cream crystallization process

Céline Casenave, Denis Dochain, Graciela Alvarez, Marcela Arellano, Hayat Benkhelifa, Denis Leducq

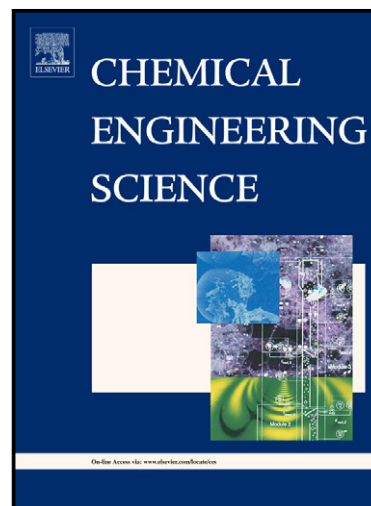

[www.elsevier.com/locate/ces](http://www.elsevier.com/locate/ces)

PII: S0009-2509(14)00448-5  
DOI: <http://dx.doi.org/10.1016/j.ces.2014.08.030>  
Reference: CES11827

To appear in: *Chemical Engineering Science*

Received date: 29 January 2014  
Revised date: 8 August 2014  
Accepted date: 12 August 2014

Cite this article as: Céline Casenave, Denis Dochain, Graciela Alvarez, Marcela Arellano, Hayat Benkhelifa, Denis Leducq, Model identification and reduction for the control of an ice cream crystallization process, *Chemical Engineering Science*, <http://dx.doi.org/10.1016/j.ces.2014.08.030>

This is a PDF file of an unedited manuscript that has been accepted for publication. As a service to our customers we are providing this early version of the manuscript. The manuscript will undergo copyediting, typesetting, and review of the resulting galley proof before it is published in its final citable form. Please note that during the production process errors may be discovered which could affect the content, and all legal disclaimers that apply to the journal pertain.

# Model identification and reduction for the control of an ice cream crystallization process<sup>☆</sup>

Céline Casenave<sup>a</sup>, Denis Dochain<sup>b</sup>, Graciela Alvarez<sup>c</sup>, Marcela Arellano<sup>d</sup>,  
Hayat Benkhelifa<sup>e</sup>, Denis Leducq<sup>c</sup>

<sup>a</sup>*MODEMIC project-team, INRA/INRIA, 2 place Pierre Viala, 34060 Montpellier, France (e-mail: celine.casenave@supagro.inra.fr).*

<sup>b</sup>*ICTEAM, UCL, 4 avenue Georges Lemaître 1348 Louvain-la-neuve, Belgium (e-mail: denis.dochain@uclouvain.be)*

<sup>c</sup>*IRSTEA, 1 rue Pierre-Gilles de Gennes, 92160 Antony, France (e-mail: {graciela.alvarez, denis.leducq}@irstea.fr)*

<sup>d</sup>*School of Chemical Engineering, University of Birmingham, Edgbaston, Birmingham, B15 2TT, United Kingdom.*

<sup>e</sup>*AgroParisTech, UMR n° 1145 Ingénierie-Procédés-Aliments, 16 rue Claude Bernard, 75231 Paris Cedex 05, France. (e-mail: hayat.benkhelifa@agroparistech.fr)*

---

## Abstract

Ice cream crystallization processes can be modeled by some population and energy balance equations. Due to the infinite dimensional and nonlinear characteristics, such models are highly complex, especially when all the phenomena of nucleation, growth and breakage are considered. Depending on the control problem under consideration, such a complexity can be useless and the control law can be designed on the basis of an input-output reduced order model of the process. In the present paper, we first consider a reduced order model of 6 ordinary differential equations obtained by the method of moments. By means of a sensitivity analysis and a parameter identification,

---

<sup>☆</sup>This work was supported by the 7<sup>th</sup> Framework Program of the European Union: CAFE Project (Computer-Aided Food processes for control Engineering project) - Large Collaborative Project KBBE-2007-2-3-01.

it is shown that, to accurately describe the input-output behavior of the system whatever the conditions are, it is sufficient to change the values of only two parameters of this model, which is really interesting from a control point of view. However, when looking at the simulated data, the complexity of this moments model appears useless, from the input-output point of view. A second model reduction is therefore performed, based on physical assumptions. We finally get a new model with 3 ordinary differential equations, which is validated first on experimental data and then by comparison with the initial moments model.

*Keywords:* ice cream crystallization, particulate processes, population balance equation, model identification, model reduction, process control

---

## 1. Introduction

Crystallization (e.g. Mullin (2001)) is encountered in many processes, in particular in the pharmaceutical industry and the food industry (Hartel, 2001). In crystallization processes, an important challenge is to control the quality and/or the properties of the product. In the case of ice creams, it is well known that the quality, that is the hardness and the texture of the ice cream, depends on the ice crystal size distribution (CSD). For example, depending on the mean crystal size, or more precisely on the dispersion of crystal sizes (that is on the shape of the CSD), the obtained texture of the ice cream is more or less grainy. Some physical properties of the ice cream, as for example its viscosity, also depend on the CSD, or at least on its moments.

In the model considered in this paper, the evolution of the CSD is described by a population balance equation (PBE) (Randolph, 1971; Costa

et al., 2007) to which an energy balance equation is added. Due to the infinite dimensional and nonlinear characteristics, the model is highly complex, especially when all the phenomena of nucleation, growth and breakage (Cook and Hartel, 2010) are considered. To control such a system, and more generally the particulate processes, there exists several approaches (see for example Christofides et al. (2008) and Nagy et al. (2008)). In some papers, the proposed control law is designed directly from the PBE (Mesbah et al., 2012; Sheikhzadeh et al., 2008). It enables to take into account the whole complexity of the system dynamics but in return, it often needs sophisticated mathematical tools and can lead to some complex controllers, not always easy to implement. That's why most of the time, a reduced order model (*early lumping* - see Ray (1978)) is considered. Some examples of model reduction techniques for particulate processes can be found in Christofides (2002), Dokucu et al. (2008) or Motz et al. (2004). One of these techniques consists in applying the method of moments (Christofides, 2002), which transforms the PBE in an infinite set of moments equations (ordinary differential equations - ODEs). The number of moments equations we will finally keep, and the closure of the truncated system are some important questions. In our case, the first four moment equations are independent of the higher order ones, and the energy balance equation only involves moments of order 3 or less, so that the system we consider is finally reduced to a set of 5 ODEs. Note that this model is not well adapted for all control problems. In particular, the control of the shape of the CSD, which is of importance in crystallization processes (Vollmer and Raisch, 2006; Nagy, 2008; Ma and Wang, 2012), is not the kind of problems we will focus on. Indeed, it is well known that the

reconstruction of a distribution from its moments is really difficult. However, the control of all quantities which can be expressed as a function of the 4 first moments and of the ice temperature (Mantzaris and Daoutidis, 2004) can be performed on the basis of this reduced order moments model.

The first part of the paper deals with the identification of the model parameters and the validation of this model by comparison with experimental data. A sensitivity analysis is performed in order to determine the parameters to be identified. To complete the model of 5 ODEs, an additive equation, which describes the dynamics of the compressor of the crystallizer is proposed and identified from experimental data.

One objective of the present paper is also to propose (and identify) a model suitable for control purposes, that is, which appropriately describes the dynamic input-output behavior of the system. In our case, we are interested in the dynamical response of the saturation temperature<sup>1</sup> to the variations of the refrigerant fluid temperature. To approximate such a dynamic behavior, some of the state variables of the model appear to be useless (when looking at the simulated data). Based on physical assumptions, a second model reduction is therefore proposed which finally leads to a new model only composed of 3 ODEs.

The paper is organized as follows. The experimental setup and the model of the crystallizer are described in sections 2 and 3. The identification of the moments model from experimental data is then presented in section 4. To

---

<sup>1</sup>The saturation temperature of the ice is a threshold temperature, below which the crystallization occurs. It can be linked to the ice cream viscosity, the control of which is interesting in a production point of view.

complete the modeling, a model of the compressor is proposed and identified in section 5. Some examples of simulated trajectories are finally compared with experimental data in section 6. In section 7 the second model reduction is presented. Finally a comparison between the moments model and the reduced order one is performed in section 8.

## 2. Process description

### 2.1. Pilot plant

The pilot plant is located at IRSTEA Antony (France). The ice cream crystallizer is a 0.40 meter long cylindric Scraped-Surface Heat Exchanger (SSHE), with inner diameter of 0.05 meter (see Figure 1). The sorbet mix, which is mainly composed of sugar, gum and water, is first put in a mix storage tank which is refrigerated at a temperature  $T_0$  of 5°C. The sorbet mix is then fed to the crystallizer by a piston pump with a mass flow rate denoted  $m_{fr}$ . Within the vessel jacket of the crystallizer, a refrigerant fluid (R22), whose temperature  $T_e$  is called the evaporation temperature, is continually vaporizing to cool down the sorbet mix and mainly to crystallize (to freeze) water in the sorbet. When the temperature of the sorbet mix goes below the saturation temperature (denoted  $T_{sat}$ ), the crystallization occurs. Some ice crystals appear on the inner wall of the cylinder and are scraped by two scraper blades which turn with a rotation speed denoted  $N_{scrap}$  and so mix the ice.

The dasher rotation speed  $N_{scrap}$  and the mass flow rate  $m_{fr}$  can be varied directly by the user, which is not the case of the evaporation temperature  $T_e$ . The temperature of the refrigerant fluid is indeed modified by means of a

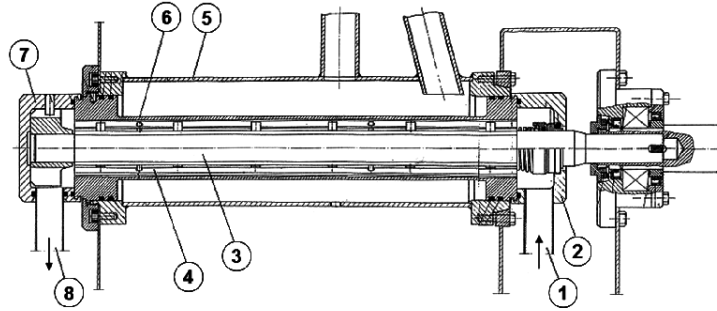

Figure 1: **Schematic representation of the SSHE (Scraped-Surface Heat Exchanger) WCB Model MF 50.** 1. Inlet connection for sorbet mix. 2. Inlet cover bowl. 3. Rotor. 4. Scraper blades rows. 5. Heat exchange cylinder jacket with vaporizing R22. 6. Heat exchange cylinder. 7. Outlet cover bowl. 8. Outlet pipe for sorbet.

compressor, whose rotation speed is denoted  $V_{\text{comp}}$ . The ranges of admissible values for the 3 inputs  $V_{\text{comp}}$ ,  $N_{\text{scrap}}$  and  $m_{\text{fr}}$  are given in Table 1.

Inputs	Lower bound	Upper bound
Compressor rotation speed $V_{\text{comp}}$	500 rpm	2600 rpm
Dasher rotation speed $N_{\text{scrap}}$	300 rpm	1000 rpm
Mass flow rate $m_{\text{fr}}$	20 kg.h <sup>-1</sup>	100 kg.h <sup>-1</sup>

Table 1: **Bounds on the control inputs.** rpm stands for 'rotation per minute'.

## 2.2. Available measurements

Two variables are accessible for on-line measurement : the outlet temperature  $T$  of the ice cream and the evaporation temperature  $T_e$ . These quantities are measured every 5 seconds.

The temperature  $T$  is not measured directly at the outlet of the freezer, but further in the outlet pipe. At the measurement point, the temperature  $T$  can be reasonably considered to be equal to the saturation temperature  $T_{\text{sat}}$ . Indeed, inside the freezer, the temperature is lower than the saturation temperature so that the crystallization can proceed. But, when the ice



leaves the reactor through a non refrigerated pipe, there is no more crystallization. The temperature of the ice increases until it reaches the saturation temperature value. The location of the measurement point at some distance of the reactor outlet also generates measurement delay. By denoting  $T_{\text{sat,m}}$  the temperature measurement, we can assume that :

$$T_{\text{sat,m}}(t) = T_{\text{sat}}(t - d) \quad (1)$$

where  $T_{\text{sat}}$  is the saturation temperature of the ice at the outlet of the freezer and  $d$  is the measurement delay.

Note that the ice mean chord length (MCL) of sorbet was also measured by using the focus beam reflectance method (FBRM) (see in Arellano et al. (2012)). As these measurements are only made at equilibrium, they are only used to validate the model reduction (see section 7.1).

**Remark 1.** The moments of the CSD are quantities that are often not measurable directly. They may appear to be related under some conditions to the geometrical properties of the crystal or to some physical quantities. In our study, we will see that the saturation temperature gives an indirect measurement of the third moment  $M_3$  of the CSD, whereas the mean chord length is related to the ratio of moments  $\frac{M_1}{M_0}$ .

### 3. Model of the crystallizer

The model of the crystallizer considered in this paper is composed of one population balance equation describing the evolution of the CSD inside the

freezer, and one energy balance equation. The definitions and units<sup>2</sup> of all the variables used in the sequel are given in Table 2.

### 3.1. Balance Equations

The ice cream crystallizer under consideration is a scraped surface heat exchanger which is assumed to behave as a plug flow reactor. The population balance equation considers transport, crystal growth, nucleation and breakage, the radial diffusion being assumed to be negligible. If the plug flow reactor is approximated, from an input-output point of view, by a Continuous Stirred-Tank Reactor (CSTR) with a transport delay<sup>3</sup> (to account for the fluid transport in the freezer), then we get the following simplified equation :

$$\frac{\partial \Psi}{\partial t} = \underbrace{-D\Psi}_{\text{transport}} - \underbrace{\frac{\partial(G\Psi)}{\partial L}}_{\text{growth}} + \underbrace{N\delta_{(L-L_c)}}_{\text{nucleation}} + \underbrace{B_b}_{\text{breakage}} \quad (2)$$

where  $\delta$  denotes the Dirac function and the dilution rate  $D$  is deduced from the mass flow rate  $m_{fr}$  by the relation:

$$D = \frac{m_{fr}}{\rho_s V}. \quad (3)$$

**Growth term:** the growth rate is assumed to be independent of the

---

<sup>2</sup>The units of the variables are the S.I. Units, except for the rotation speeds  $N_{scrap}$  and  $V_{comp}$  which are expressed in revolution per second ( $r.s^{-1}$ ) instead of radians per second.

<sup>3</sup>The transport delay does not appear in the equation (2) and (7) because the input variables, that is the CSD and the temperature of the mix at the inlet of the freezer, are constant variables.

	Definition	Unit
$\Psi$	number of crystals per meter (of the freezer) per cubic meter of the solution at the outlet of the freezer	$\text{m}^{-4}$
$M_j$	$j^{\text{th}}$ order moment	$\text{m}^{j-3}$
$t$	time variable	s
$r$	radial position variable	m
$L$	crystal size variable	m
$L_c$	initial crystal size	m
$R_i$	freezer minimum diameter	m
$R_e$	freezer maximum diameter	m
$G$	growth rate of the crystals	$\text{m}\cdot\text{s}^{-1}$
$N$	nucleation rate	$\text{m}^{-4}\cdot\text{s}^{-1}$
$B_b$	net increase of crystals number by breakage	$\text{m}^{-4}\cdot\text{s}^{-1}$
$T_{\text{sat}}$	saturation temperature	$^{\circ}\text{C}$
$T_e$	evaporation temperature	$^{\circ}\text{C}$
$T$	ice temperature	$^{\circ}\text{C}$
$T_0$	inlet mix temperature	$^{\circ}\text{C}$
$\alpha$	surface nucleation constant	$\text{m}^{-2}\cdot\text{s}^{-1}\cdot\text{K}^{-2}$
$\beta$	growth constant	$\text{m}\cdot\text{s}^{-1}\cdot\text{K}^{-1}$
$V$	volume of the freezer	$\text{m}^3$
$\phi_i$	ice fraction	-
$N_{\text{scrap}}$	dasher rotation speed	$\text{r}\cdot\text{s}^{-1}$
$V_{\text{comp}}$	compressor rotation speed	$\text{r}\cdot\text{s}^{-1}$
$\nu$	breakage power coefficient	-
$\epsilon$	breakage constant	$\text{m}^{-1}$
$\omega$	mass fraction of solutes in the unfrozen phase	-
$\omega_0$	initial mass fraction of solute (sucrose)	-
$\rho_i$	mass density of ice	$\text{kg}\cdot\text{m}^{-3}$
$\rho_s$	mass density of solution	$\text{kg}\cdot\text{m}^{-3}$
$U$	volumetric internal energy	$\text{J}\cdot\text{m}^{-3}$
$\mu$	viscosity	$\text{Pa}\cdot\text{s}$
$\dot{\gamma}$	effective shear rate	$\text{s}^{-1}$
$\mu_{\text{mix}}$	viscosity of the unfrozen phase	$\text{Pa}\cdot\text{s}$
$\chi$	viscous dissipation coefficient	-
$\xi$	adjustment parameter of the viscosity	-
$\Delta H$	specific fusion latent heat	$\text{J}\cdot\text{kg}^{-1}$
$C_s$	solute specific heat capacity	$\text{J}\cdot\text{kg}^{-1}\cdot\text{K}^{-1}$
$C_w$	water specific heat capacity	$\text{J}\cdot\text{kg}^{-1}\cdot\text{K}^{-1}$
$h_e$	convective heat transfer coefficient	$\text{W}\cdot\text{m}^{-2}\cdot\text{K}^{-1}$
$S$	ratio of the periphery over the surface of the section	$\text{m}^{-1}$
$D$	dilution rate	$\text{s}^{-1}$
$U_0$	inlet energy	$\text{J}\cdot\text{m}^{-3}$
$m_{\text{fr}}$	inlet mass flow rate	$\text{kg}\cdot\text{s}^{-1}$

Table 2: Nomenclature.

crystal size; it is given by:

$$G = \beta(T_{\text{sat}} - T). \quad (4)$$

In this expression, the physical meaning of the saturation temperature  $T_{\text{sat}}$  is respected: it is a threshold temperature, below which (if  $T < T_{\text{sat}}$ ) the crystallization occurs, and the crystals grow ( $G > 0$ ). On the contrary, if  $T > T_{\text{sat}}$  (in warm temperature zones), the crystals are melting and  $G < 0$ .

**Nucleation term:** the nucleation phenomenon consists in the formation of crystals whose size is here assumed to be characterized by  $L_c$ . Only heterogeneous nucleation at the freezer wall ( $r = R_e$ ) is considered here. The nucleation rate  $N$  is expressed by:

$$N = \alpha \frac{2\pi R_e}{V} (T_{\text{sat}} - T_e)^2 > 0. \quad (5)$$

**Breakage term:** because of the scraper, the crystals can also be broken. We assume that a particle of size  $L'$  is broken into two particles of the same size  $L$ . The total volume of ice is considered unchanged by the fragmentation<sup>4</sup> and a spherical shape is assumed (as in Arellano et al. (2013)). Under these assumptions, the relation between  $L'$  and  $L$  is given by  $L' = 2^{1/3}L$  and the net increase of particles by breakage  $B_b$ , can be expressed as in Arellano et al. (2013) by:

$$B_b = \epsilon N_{\text{scrap}} \phi_i^\nu \left( 2 \cdot 2^{2/3} L \Psi(\sqrt[3]{2} L) - L \Psi(L) \right). \quad (6)$$

---

<sup>4</sup>The sum of the volume of the 2 crystals of size  $L$  equals the volume of the crystal of size  $L'$ .

The breakage power coefficient  $\nu$  is taken equal to 0, as in Gonzalez et al. (2011).

Under the same hypotheses than for the population balance equation, the energy balance equation is written as follows :

$$\frac{dU}{dt} = \underbrace{D(U_0 - U)}_{\text{transport}} + \underbrace{h_e S(T_e - T)}_{\text{wall heat transfer}} + \underbrace{\mu \dot{\gamma}^2}_{\text{viscous dissipation}} \quad (7)$$

$$\text{with: } \dot{\gamma} = 2\pi\chi N_{\text{scrap}} \text{ and } S = \frac{2R_e}{R_e^2 - R_i^2}. \quad (8)$$

### 3.2. Moments model

Applying the method of moments<sup>5</sup> to equation (2), we get, for all  $j \geq 0$  (Gonzalez et al. (2011)) :

$$\frac{dM_j}{dt} = -DM_j + jGM_{j-1} + NL_c^j + B \left( 2^{1-\frac{j}{3}} - 1 \right) M_{j+1} \quad (9)$$

where  $M_j(t) = \int_0^\infty L^j \Psi(L, t) dL$  is the  $j^{\text{th}}$  order moment of the CSD, and:

$$B = \epsilon N_{\text{scrap}}. \quad (10)$$

Moreover the equation (7) can be rewritten with the temperature  $T$  as the state variable by using the following relation :

$$U = -\Delta H \rho_i \phi_i + \rho_s (\omega_0 C_s + (1 - \omega_0) C_w) T. \quad (11)$$

---

<sup>5</sup>The method of moments consists in multiplying the population balance equation by  $L^j$  and then integrating it from  $L = 0$  to  $L = \infty$ .

If we consider the ice crystals as spherical particles (as in Arellano et al. (2013)), then we have:

$$\phi_i = \frac{\pi}{6} M_3, \quad (12)$$

which, after computations, leads to :

$$\frac{dT}{dt} = D(T_0 - T) + K_2(T_e - T) + N_{\text{scrap}}^2 K_3 \mu + K_1(3GM_2 + NL_c^3) \quad (13)$$

with the following quantities :

$$K_0 = \rho_s(\omega_0 C_s + (1 - \omega_0)C_w), \quad T_0 = \frac{U_0}{K_0}, \quad (14)$$

$$K_1 = \frac{\pi}{6} \frac{\Delta H \rho_i}{K_0}, \quad K_2 = \frac{h_e S}{K_0}, \quad K_3 = \frac{(2\pi\chi)^2}{K_0}. \quad (15)$$

The saturation temperature is supposed to depend only on  $M_3$ , that is  $T_{\text{sat}} = T_{\text{sat}}(M_3)$ . As a consequence,  $G$  and  $N$  can be expressed as functions of the variables  $M_3$  and  $T$ , and  $M_3$  and  $T_e$  respectively (i.e.  $G = G(M_3, T)$  and  $N = N(M_3, T_e)$ ). So, if the viscosity  $\mu$  is assumed to depend only on the third moment  $M_3$ , the temperature  $T$ , and the dasher rotation speed  $N_{\text{scrap}}$  (i.e.  $\mu = \mu(M_3, T, N_{\text{scrap}})$ ), then the system composed of the four first moment equations and the temperature equation is closed. The closure of the system derives from the assumptions that the total volume of ice is preserved by the fragmentation, and that the crystals are spherical. Indeed, under these hypotheses, the third moment  $M_3$  is proportional to the total volume of ice, and, as a consequence, is also preserved by the fragmentation. Concretely, these assumptions lead to the cancellation of the breakage term in the equation of  $M_3$  ( $2^{1-\frac{j}{3}} - 1 = 0$  for  $j = 3$ ), and therefore to the closure

of the equations of moments.

In the sequel we shall therefore consider the following model :

$$\frac{dM_0}{dt} = -DM_0 + N + BM_1 \quad (16)$$

$$\frac{dM_1}{dt} = -DM_1 + GM_0 + NL_c + c_1BM_2 \quad (17)$$

$$\frac{dM_2}{dt} = -DM_2 + 2GM_1 + NL_c^2 + c_2BM_3 \quad (18)$$

$$\frac{dM_3}{dt} = -DM_3 + 3GM_2 + NL_c^3 \quad (19)$$

$$\frac{dT}{dt} = D(T_0 - T) + K_2(T_e - T) + N_{\text{scrap}}^2 K_3 \mu + K_1(3GM_2 + NL_c^3) \quad (20)$$

with  $\mu = \mu(M_3, T, N_{\text{scrap}})$ ,  $G = G(M_3, T)$ ,  $N = N(M_3, T_e)$ ,  $B = B(N_{\text{scrap}})$  and the constants  $c_1 = 2^{\frac{2}{3}} - 1$  and  $c_2 = 2^{\frac{1}{3}} - 1$ .

This model is a dynamic version of the one developed by research teams of AgroParisTech and IRSTEA Antony (France), and described in Arellano et al. (2013) and Gonzalez et al. (2011).

### 3.3. Characteristic quantities of the product

The saturation temperature and the viscosity of the ice both depend on the formula of the mix used (mainly on ingredients content) and on the desired final product. The sorbet considered in this study is only composed of water, gum and sugar, and no air is added during the crystallization.

**Saturation temperature:** the expression of the saturation temperature (in [°C]) has been determined experimentally from the commercial mix (Gonzalez, 2012); it is given by:

$$T_{\text{sat}}(M_3) = -7.683\omega + 8.64\omega^2 - 70.1\omega^3, \quad (21)$$

where, the mass fraction of sugar in the unfrozen phase,  $\omega$ , depends on the ice fraction  $\phi_i$  in the following way:

$$\omega = \frac{\omega_0}{1 - \frac{\rho_i}{\rho_s} \phi_i} = \frac{\omega_0}{1 - \frac{\rho_i \pi}{\rho_s 6} M_3}. \quad (22)$$

According to the “liquidus curve” experimentally determined for the sorbet mix in Gonzalez (2012),  $T_{\text{sat}}$  is a decreasing function<sup>6</sup> of  $M_3$ .

**Viscosity:** the expression of the viscosity (in [Pa.s]) has been obtained empirically in Gonzalez (2012); it is given by:

$$\mu(M_3, T, N_{\text{scrap}}) = \mu_{\text{mix}} \times (1 + 2.5 \phi_i + 10.05 \phi_i^2 + 0.00273 \xi e^{16.6 \phi_i}), \quad (23)$$

where  $\mu_{\text{mix}}$ , the viscosity of the unfrozen phase, is given by:

$$\mu_{\text{mix}} = 39.02 \times 10^{-9} \times \dot{\gamma}^{0.600-1} e^{\frac{2242.38}{T+273}} \times (100 \omega)^{2.557}. \quad (24)$$

#### 4. Parameter identification and validation of the model of the crystallizer

The model under consideration in this paper will then be used for a control purpose. More precisely, the goal is in the end to control the saturation temperature of the ice cream at the outlet of the freezer. As the control input is the evaporation temperature, the objective of the modeling is to accurately describe the input-output behavior of the system, that is the dy-

---

<sup>6</sup>The derivative of function  $T_{\text{sat}}$  is given by  $T'_{\text{sat}}(M_3) = \frac{\rho_i \pi}{\rho_s 6} \frac{\omega^2}{\omega_0} \times (-7.683 + 2 \times 8.64\omega - 3 \times 70.1\omega^2) < 0$ .



namical response of the saturation temperature  $T_{\text{sat}}$  to the input  $T_e$ . As a consequence, the model will be validated by comparison between the simulated saturation temperature values and the measured ones. Before that, a sensitivity analysis followed by an identification step will be performed, to first determine the more sensitive parameters and then estimate their values. For a review about model identification for crystallization processes, one can refer to Rawlings et al. (1993).

#### 4.1. Sensitivity analysis

Before identifying the parameters model, we first study the sensitivity of the model to its parameters. To evaluate the effect of the variation of a parameter on the model, we use the following quantity (as in Bernard et al. (2001)):

$$\sigma_x(p) = \frac{1}{T} \int_{t_0}^{t_0+T} \left| \frac{x(t, X_0, p) - x(t, X_0, p^{\text{ref}})}{x(t, X_0, p^{\text{ref}})} \right| dt, \quad (25)$$

where  $x$  is a variable of the model,  $p$  is the parameter,  $X_0$  is the initial conditions of the model,  $t_0$  is the initial time and  $t_0 + T$  the given final time,  $p^{\text{ref}}$  is the reference value of parameter  $p$  and  $x(t, X_0, p)$  is the value of the variable  $x$  at time  $t$  obtained by simulation of the model with initial conditions  $X_0$  and parameters value  $p$ . The quantity  $\sigma_x(p)$  can be viewed as a mean relative difference between the reference value  $x(t, X_0, p^{\text{ref}})$  of  $x$  and the one obtained for the parameter value  $p$ .

The value of  $\sigma_x(p)$  has been computed for the parameters  $\epsilon$ ,  $L_c$ ,  $\alpha$ ,  $\beta$ ,  $h_e$ ,  $\xi$  and  $\chi$ , which, among all the parameters of the model, are the ones which are either ill-known or possibly dependent on some neglected phenomena or external environmental conditions (as, for example, the temperature of the

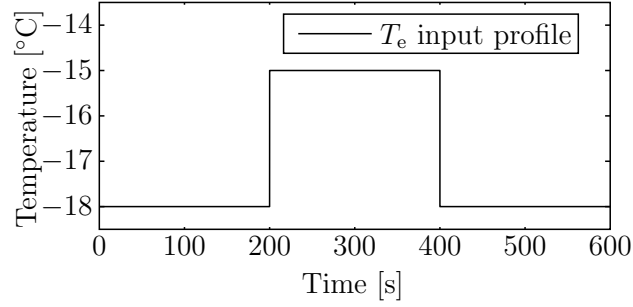

Figure 2: **Sensitivity analysis:** profile of the input  $T_e$  used for the computation of  $\sigma_x(p)$ .

room in which the freezer is located). In comparison,  $R_i$ ,  $R_e$ ,  $V$  are some constant physical parameters depending on the geometry of the freezer;  $\rho_i$ ,  $\rho_s$ ,  $\Delta H$ ,  $C_s$ ,  $C_w$  are well-known constants; and  $\omega_0$  and  $T_0$  respectively depend on the mix and the process.

As for the variable  $x$ , the effect on all the state variables  $M_0$ ,  $M_1$ ,  $M_2$ ,  $M_3$ , and  $T$  and the one on  $T_{\text{sat}}$  have been studied. However, as explained before, we focus more specifically on the dynamical response of the saturation temperature.

The choice of the reference trajectories of the model is obviously important. They have been obtained by simulation of the model with the following input variable values:  $N_{\text{scrap}} = 750$  rpm and  $m_{\text{fr}} = 50$  kg.h<sup>-1</sup>; the initial conditions  $M_0(0) = M_1(0) = M_2(0) = M_3(0) = 0$ ,  $T(0) = T_0$  which correspond to the starting up of the process; and the constant parameter values given in Table 3. The input profile of the evaporation temperature is the one given in Figure 2. Finally, the initial and final times are respectively taken equal to  $t_0 = 200$  s and  $t_0 + T = 600$  s, time instants at which the process is stabilized.

The results are given in Figure 3.

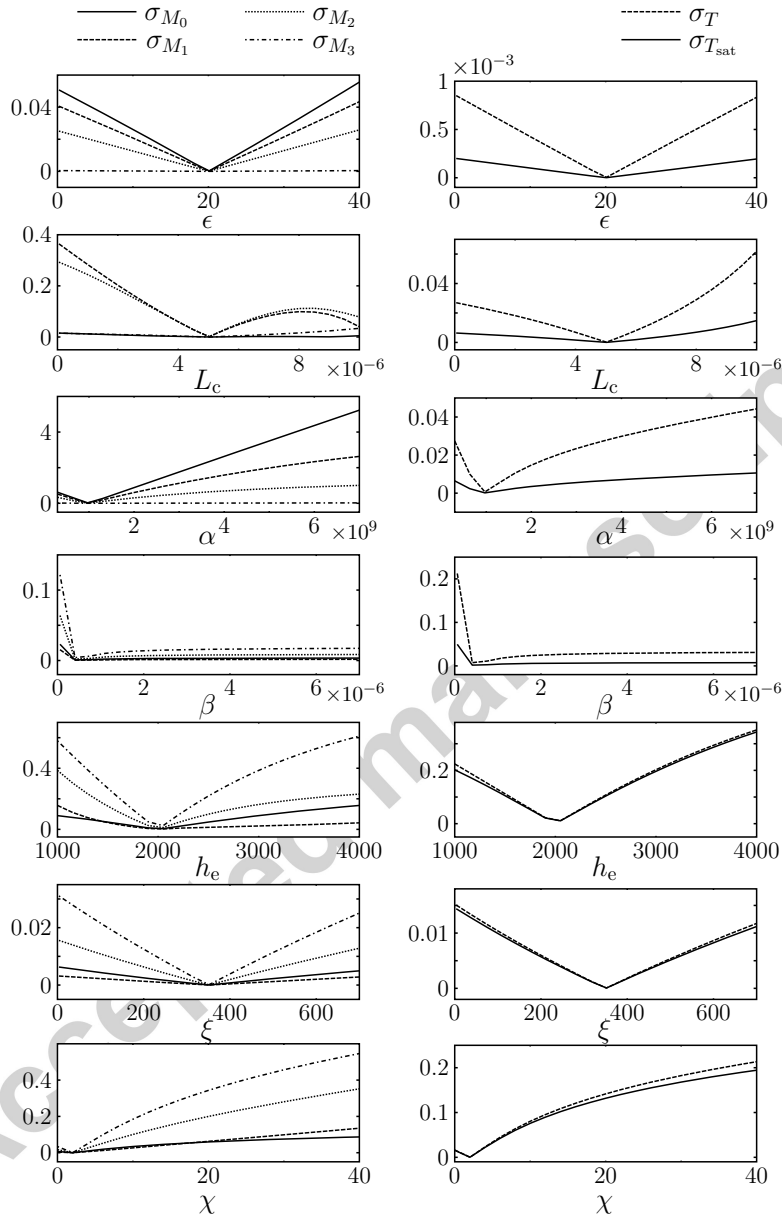

Figure 3: **Sensitivity analysis:** evolution of the quantity  $\sigma_x(p)$  defined by (25) for different parameters and variables of the model, for  $p$  going from  $b_{\min}$  to  $b_{\max}$  (see Table 4).

$T_0$	5°C	$L_c$	$5 \cdot 10^{-6}$ m	$\rho_i$	1000 kg.m <sup>-3</sup>
$\nu$	0	$R_i$	0.016 m	$\rho_s$	1100 kg.m <sup>-3</sup>
$\epsilon$	20 m <sup>-1</sup>	$R_e$	0.025 m	$\Delta H$	333.6 10 <sup>3</sup> J.kg <sup>-1</sup>
$\omega_0$	0.25	$\alpha$	$1 \cdot 10^9$ m <sup>-2</sup> .s <sup>-1</sup> .K <sup>-2</sup>	$C_s$	1676 J.kg <sup>-1</sup> .K <sup>-1</sup>
$\chi$	2	$\beta$	$5 \cdot 10^{-7}$ m.s <sup>-1</sup> .K <sup>-1</sup>	$C_w$	4187 J.kg <sup>-1</sup> .K <sup>-1</sup>
$\xi$	350	$V$	$3.87 \cdot 10^{-4}$ m <sup>3</sup>	$h_e$	2000 W.m <sup>-2</sup> .K <sup>-1</sup>

Table 3: **Sensitivity analysis:** constant parameters values used for the simulation of the reference trajectories (chosen according to Arellano et al. (2013) and Gonzalez et al. (2011)).

parameter	unit	$b_{\min}$	$b_{\max}$
$\epsilon$	m <sup>-1</sup>	0	40
$L_c$	m	0	10 <sup>-6</sup>
$\alpha$	m <sup>-2</sup> .s <sup>-1</sup> .K <sup>-2</sup>	$3 \times 10^8$	$7 \times 10^9$
$\beta$	m.s <sup>-1</sup> .K <sup>-1</sup>	0	$7 \times 10^{-6}$
$h_e$	W.m <sup>-2</sup> .K <sup>-1</sup>	1000	4000
$\xi$	–	0	700
$\chi$	–	0	40

Table 4: **Sensitivity analysis:** minimum and maximum bounds  $b_{\min}$  and  $b_{\max}$  of the parameters on which the sensibility analysis has been performed.

First note that the variations of  $\epsilon$ ,  $L_c$ ,  $\alpha$  and  $\xi$  have a very low impact on  $T_{\text{sat}}$ . The parameter  $\epsilon$  is the breakage constant; as we assume that the volume of the ice is conserved when a crystal is divided by breakage, it can be expected that  $M_3$  (and so  $T_{\text{sat}}$ ) that represents the volume of crystals per cubic meter, is not very much affected by a variation of  $\epsilon$ . The possible values of  $L_c$  are very small: the effect of the considered variations of  $L_c$  still remains too small to affect the value of  $M_3$ . This obviously makes sense, because  $L_c$  is linked to the nucleation phenomenon, by which the number of crystals, and not the volume, increases. For the same reason, the effect of the variation of the surface nucleation constant  $\alpha$  is also small. Finally  $\xi$  is related to the viscosity term of the model, which, for the considered range of parameter variation, does not influence the volume of the crystals a lot.

The growth constant  $\beta$  influences the value of  $T_{\text{sat}}$  more than the preceding parameters. This is physically consistent with the fact that the volume of the ice depends on the growth rate  $G$ . But the parameters which at the most affect  $T_{\text{sat}}$  are  $h_e$  and  $\chi$ . It is not surprising as  $h_e$  is the convective heat transfer coefficient, which consequently has a direct impact on both temperatures  $T$  and  $T_{\text{sat}}$ , and  $\chi$  is the viscous dissipation coefficient on which depends the temperature of the ice.

#### 4.2. Identification of the parameters

According to the sensitivity analysis performed in Section 4.1, the saturation temperature  $T_{\text{sat}}$  is mostly influenced by the parameters  $h_e$  and  $\chi$ . Let's now see if the identification of these two parameters is sufficient to obtain simulated trajectories close to the experimental data.

For that, we have performed several identifications from 12 sets of experimental data. The identifications were made on each of the 12 experimental data sets separately. Indeed, as it will be discussed later, some parameters of the model depend on some neglected phenomena or external environmental conditions and can therefore vary from one experiment to the other. As a consequence, it is impossible to find a unique set of parameter values for which the model will explain well the 12 experimental data sets together.

For each  $i = 1 : 12$ , that is for each experimental data set, we will denote in the sequel  $N^i$  the number of measurement instants,  $t^{k,i}$ ,  $k = 1 : N^i$  the measurement instants,  $T_{\text{sat},m}^{k,i}$  the measurement of the saturation temperature at time  $t^{k,i}$ ,  $d^i$  the measurement delay,  $X^{0,i}$  the initial conditions values, and  $U^{k,i}$  the control inputs values at time  $t^{k,i}$ .

To identify the parameters (vector  $p$  in the sequel) of the model, we used

the Nelder-Mead simplex method (function `fminsearch` of Matlab) to solve the least-squares minimization problem:

$$\hat{p} = \arg \min_p E^i(p) \quad (26)$$

where  $E^i(p)$  is the least-squares error on the  $i^{\text{th}}$  experimental data set which is given by:

$$E^i(p) = \frac{1}{N^i} \sum_{k=1}^{N^i} \left( T_{\text{sat}}(t^{k,i} - d^i, X^{0,i}, U^{k,i}, p) - T_{\text{sat,m}}^{k,i} \right)^2, \quad (27)$$

with  $T_{\text{sat}}(t^{k,i} - d^i, X^{0,i}, U^{k,i}, p)$  the value of the saturation temperature at time  $t^{k,i} - d^i$  obtained by simulation of the model (16-20) with initial conditions  $X^{0,i}$ , control inputs values  $U^{k,i}$  and parameters values  $p$ . The value of the measurement delay  $d^i$  considered for the identification is discussed in paragraph 4.4. The control inputs values  $U^{k,i}$  are either known (the mass flow rate  $m_{\text{fr}}$  and the dasher rotation speed  $N_{\text{scrap}}$ ) or measured (the evaporation temperature  $T_e$ ). As for the initial conditions  $X^{0,i} = (M_0^{i,0}, M_1^{i,0}, M_2^{i,0}, M_3^{i,0}, T^{i,0})$ , they are deduced from the measurements  $T_{\text{sat,m}}^{k,i}$  of  $T_{\text{sat}}$  in the following way:

$$M_3^{i,0} = T_{\text{sat}}^{-1}(T_{\text{sat,m}}^{0,i}), \quad (28)$$

where  $T_{\text{sat}}^{-1}$  is the inverse of the restriction of function  $T_{\text{sat}}$  (see formula (21))

to the interval  $\left[0, \frac{\rho_s}{\rho_i} \frac{6}{\pi}\right]$  of admissible physical values<sup>7</sup> of  $M_3$ ; and:

$$\forall j \neq 3, M_j^{i,0} = \frac{M_3^{i,0}}{L_c^{3-j}} \text{ and } T^{i,0} = T_{\text{sat},m}^{0,i} - 0.25. \quad (29)$$

The set of parameter values used for the initialization of the identification is the one given in Table 3.

The set of parameters to be identified has been divided in 3 subsets, depending on their influence on the saturation temperature value. We then have<sup>8</sup>:

- subset 1:  $h_e$  and  $\chi$ , the most influential parameters;
- subset 2:  $\beta$  whose influence on  $T_{\text{sat}}$  is lower;
- subset 3:  $\alpha$ ,  $\xi$  and  $L_c$ , the less influential parameters.

Based on these 3 subsets, we have performed different identifications, the number of identified parameters varying from 1 to 6 as explained in Table 5. In this table the distribution of the identified parameters in the 3 subsets is given, depending on the total number of identified parameters. For example, for an identification of 5 parameters, we will have: 2 parameters of the subset 1 (that is  $h_e$  and  $\chi$ ), 1 parameter of the subset 2 (that is  $\beta$ ) and 2 parameters of the subset 3 (that is either  $\alpha$  and  $\xi$ ,  $\alpha$  and  $L_c$ , or  $\xi$  and  $L_c$ ). The values of the parameters which are not identified are the ones given in Table 3.

---

<sup>7</sup>Indeed, the mass fraction of solutes in the unfrozen phase  $\omega$  is necessarily positive. From (22), we then deduce that  $M_3 < \frac{\rho_s}{\rho_i} \frac{6}{\pi}$

<sup>8</sup>Note that the parameter  $\varepsilon$  has not been identified, its influence on the saturation temperature being too small compared to any of the other parameters.

total	parameters to be identified		
	subset 1	subset 2	subset 3
1	1	–	–
2	2	–	–
3	2	1	–
4	2	1	1
5	2	1	2
6	2	1	3

Table 5: **Parameters identification of the freezer model:** Distribution of the parameters to be identified between the 3 subsets, depending on the total number of parameters to be identified.

The results are given in Table 6. The first line of the table corresponds with the reference model, that is the one characterized by the initial set of parameters given in Table 3. The identification results are then presented depending on the number of identified parameters. The quality of the identification is estimated in terms of comparison between the simulations of the identified model and the experimental data. For the identification of  $n$  parameters, we introduce the following quantities:

- $m_E^n$  and  $\sigma_E^n$ : respectively the mean value and the standard deviation, on all the 12 experiments, of the minimal value of  $E^i(p)$  on the set of all parameters distribution  $p$  of size  $n$  (see Table 5):

$$m_E^n = \frac{1}{12} \sum_{i=1}^{12} \min_{size(p)=n} E^i(p),$$

$$\sigma_E^n = \left( \frac{1}{12} \sum_{i=1}^{12} \left( \min_{size(p)=n} E^i(p) \right)^2 - m_E^2 \right)^{1/2};$$

- $p_E^n$ : the percentage of improvement of the identification results (in terms of  $m_E^n$  value, and with respect to the reference model) in comparison with the best identification results obtained with  $m < n$  identified



parameters:

$$p_E^n = 100 \times \frac{m_E^{b_n} - m_E^n}{m_E^0}, \text{ with } b_n = \arg \min_{m < n} m_E^m.$$

For each identification, only 2/3 of the data set are used to compute the estimate  $\hat{p}$ , the last 1/3 being saved for the cross validation. In Table 6, we use the subscripts *cv* and *t* to point out when the computation of  $E^i(p)$  (which appears in the expressions of  $m_E^n$  and  $\sigma_E^n$ ) has been performed on the last 1/3 of the data set (“cross validation” data) or on the whole data set (“total” set of data).

<i>n</i> : number of parameters	$m_{E_{cv}}^n$ ( $\times 10^{-2}$ )	$m_{E_t}^n$ ( $\times 10^{-2}$ )	$\sigma_{E_t}^n$ ( $\times 10^{-2}$ )	$p_{E_t}^n$ (%)
0	95.3	95.8	60.6	–
1	9.38	8.04	5.61	90.2
2	1.88	0.988	0.604	8.10
3	1.90	1.00	0.583	$-3.35 \cdot 10^{-3}$
4	1.74	0.942	0.573	$5.15 \cdot 10^{-2}$
5	1.71	0.941	0.531	$-1.85 \cdot 10^{-2}$
6	1.96	1.04	0.613	$-1.67 \cdot 10^{-1}$

Table 6: **Parameters identification of the freezer model**: estimation of the quality of the identified model depending on the number of identified parameters.

From Table 6, we first conclude that the identification process consequently increases the quality of the model. Indeed, by identifying only 1 parameter ( $h_e$  or  $\chi$ ), the value of  $m_E^0$  has been decreased of 90.2%. The results of the identification of both parameters  $h_e$  and  $\chi$  ( $n = 2$ ) are even better, the value of  $m_E^2$  being 8.10% smaller than  $m_E^1$ . However, the addition of 1 identified parameter or more ( $n \geq 3$ ) does not improve the quality of the model any more. As expected from the sensitivity analysis, the identification of the two parameters  $h_e$  and  $\chi$  is therefore sufficient to get an accurate

model (see Section 6 for a comparison between some experimental data and the associated simulated trajectories).

We also note that the values of  $m_{E_{cv}}^n$  are obviously greater than the ones of  $m_{E_t}^n$  (about 2 times greater) but that they are even though sufficiently small for control purposes.

#### 4.3. Comments on the identified values of parameters $h_e$ and $\chi$

The identification process presented in the previous section leads to the conclusion that the identification of parameters  $h_e$  and  $\chi$  is sufficient to get a good input-output approximation of the dynamic behavior of the process. However, each identification has been performed on each data set separately. We therefore have obtained one set of identified parameter values per data set and per identification. Let's now make a few comments about the identified values.

First focus on the identified values of  $h_e$  and  $\chi$  for a given set of data. For identifications of at least 2 parameters, the obtained identified value of  $h_e$  does not vary a lot from one identification to the other. At mean (on the 12 experiments), the standard deviation is indeed equal to  $111.7 \text{ W.m}^{-2}.\text{K}^{-1}$ , the mean values ranging from  $1800 \text{ W.m}^{-2}.\text{K}^{-1}$  to  $3600 \text{ W.m}^{-2}.\text{K}^{-1}$ . The variations of the identified value of  $\chi$  are slightly greater. To quantify these variations, we only consider identifications in which the parameter  $\xi$  is not identified. Indeed, both parameters  $\xi$  and  $\chi$  are related to the viscous dissipation term. In the input-output point of view, their respective contributions to the variation of the output value can not be distinguished by the identification process. As a consequence, when  $\xi$  is also identified, the obtained

identified values of  $\chi$  can vary a lot in comparison with other identifications. If we do not consider identifications in which  $\xi$  is identified, the mean standard deviation is equal to 0.1169, the mean values ranging from 0.01 to 1.02. The fact that the identified values of  $h_e$  and  $\chi$  do not vary a lot with respect to the number of parameters to be identified shows that their contribution to the saturation temperature dynamic are essential and can not be compensated by other parameters.

Let now look at the identified values of  $h_e$  and  $\chi$  obtained when only both of them are identified. In Table 7 the standard deviation and the minimal, maximal and mean values of  $h_e$  and  $\chi$  computed on the set of the 12 experiments are given. As we can see, the identified values can vary significantly

	min	max	mean	standard deviation
$h_e$ [W.m <sup>-2</sup> .K <sup>-1</sup> ]	1827	3486	2496	541.1
$\chi$ [-]	3.116 10 <sup>-3</sup>	0.9782	0.4223	0.3326

Table 7: **Parameters identification of the freezer model:** identified values of  $h_e$  and  $\chi$  when only both of them are identified. The standard deviation and the minimal, maximal and mean values are computed on the set of the 12 experiments.

from one experiment to the other. As a consequence, it is impossible to find a unique set of parameters values for all the experiments.

Several factors can explain the variations of the values of these parameters. For example, the heat losses to the ambiance have not been considered in the modeling: as a consequence, the parameter  $h_e$  should vary with the temperature of the room in which is located the freezer. The heat transfer between the evaporation temperature and the ice is also directly affected by the thickness of the ice layer which is formed on the wall (by nucleation). We know that this thickness vary depending on the dasher rotation speed, which is also not taken into account in the proposed model.

#### 4.4. Measurement delay

The value  $d$  of the measurement delay has also been identified from the experimental data, using an identification process similar to the one described in paragraph 4.2. The obtained identified value is given in Figure 4 as a function of the mass flow rate. As we can see, the larger the mass flow rate,

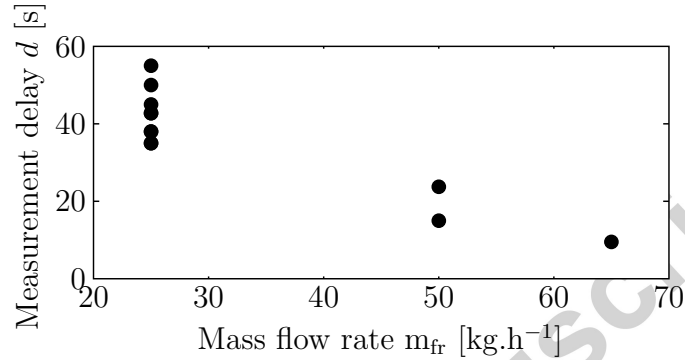

Figure 4: **Measurement delay**: identified values of the measurement delay  $d$  versus the mass flow rate  $m_{fr}$ .

the smaller the delay. Indeed, the delay measurement is mainly due to the distance between the outlet of the freezer and the measurement point: the ice reaches it more rapidly when the mass flow rate is large.

From Figure 4, we also note that, for a given value of the mass flow rate ( $m_{fr} = 25 \text{ kg.h}^{-1}$  for example), the value of the measurement delay varies from one experiment to another. This can be due to several other factors, as the viscosity of the ice, or the value of the evaporation temperature.

## 5. Model of the compressor

According to the responses of the evaporation temperature  $T_e$  to some step inputs of the compressor rotation speed  $V_{comp}$  (see Figure 5a.), the dy-

namics of the compressor (in the input  $V_{\text{comp}}$  - output  $T_e$  point of view) can be approximated by a first order equation with a nonlinear gain, i.e. :

$$\frac{dT_e}{dt} = -\frac{1}{\tau_c}T_e + \frac{1}{\tau_c}G^c, \quad (30)$$

where  $G^c = G^c(V_{\text{comp}}, m_{\text{fr}})$  is the nonlinear gain which is assumed to depend on  $V_{\text{comp}}$  and  $m_{\text{fr}}$ , and  $\tau_c$  is the time constant.  $G^c$  and  $\tau_c$  have been identified separately.

### 5.1. Identification of the time constant $\tau_c$

To identify  $\tau_c$ , we used 3 experimental data sets obtained for different step inputs of the compressor rotation speed  $V_{\text{comp}}$ . The values of  $m_{\text{fr}}$ ,  $N_{\text{scrap}}$ , and the initial and final values of the step input  $V_{\text{comp}}$  are given in Table 8 for each data set.

step number	$m_{\text{fr}}$ [kg.h <sup>-1</sup> ]	$N_{\text{scrap}}$ [rpm]	initial $V_{\text{comp}}$ [rpm]	final $V_{\text{comp}}$ [rpm]
1	25	750	750	600
2	50	652	562	1025
3	65	445	1300	750

Table 8: **Identification of the model of the compressor:** values of  $m_{\text{fr}}$ ,  $N_{\text{scrap}}$ , and the initial and final values of the step input  $V_{\text{comp}}$  for each experimental data sets used for the identification of the time constant  $\tau_c$  of the  $T_e$  dynamic.

After normalization of the data sets, we applied the Simplified Refined Instrumental Variable method for Continuous-time model (SRIVC - see Young (2002); Garnier and Young (2004)); we get the following identified value of  $\tau_c$ :

$$\tau_c = 31.77 \text{ [s]}. \quad (31)$$

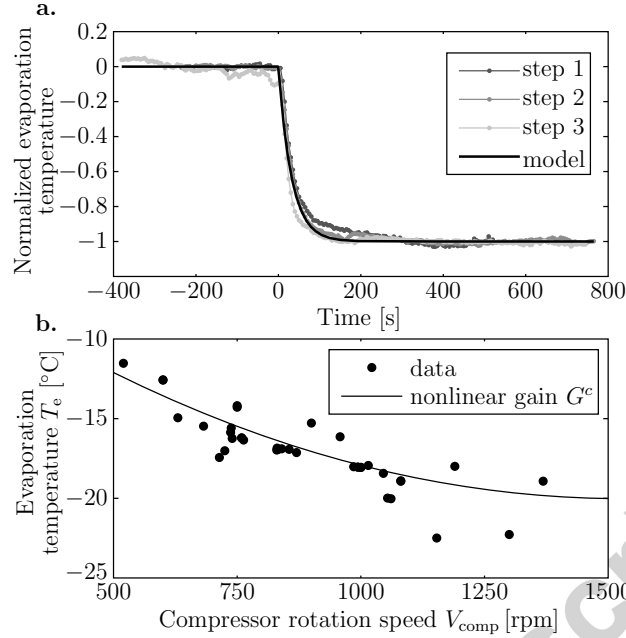

Figure 5: **Model of the compressor** a. identification of the time constant  $\tau_c$ . b. identification of the nonlinear gain  $G_c$ , for  $m_{\text{fr}} = 50 \text{ kg.h}^{-1}$  and  $N_{\text{scrap}} = 750 \text{ rpm}$ .

In Figure 5a, the trajectory obtained by simulation of model  $\frac{dy}{dt} = -\frac{1}{\tau_c}y + \frac{1}{\tau_c}u(t)$  with  $u(t) = -\mathbb{1}(t)$  and  $\tau_c$  given by (31) is compared to the experimental normalized data; as expected, the model fits well the data.

### 5.2. Identification of the nonlinear gain $G_c$

The nonlinear gain  $G_c$  has been identified from a data set composed of 68 measurements of  $T_e$  at equilibrium, obtained for different values of  $m_{\text{fr}}$  and  $V_{\text{comp}}$ , going from  $25 \text{ kg.h}^{-1}$  to  $75 \text{ kg.h}^{-1}$  for  $m_{\text{fr}}$  and from 520 rpm to 1487 rpm for  $V_{\text{comp}}$ . As identification model for the nonlinear gain  $G_c$ , a polynomial function of degree 2 of the following form has been chosen:

$$f(V_{\text{comp}}, m_{\text{fr}}) = a_0 + a_1 m_{\text{fr}} + a_2 m_{\text{fr}}^2 + a_3 V_{\text{comp}} + a_4 V_{\text{comp}}^2. \quad (32)$$

The estimations of parameters  $a_j$ ,  $j = 0 : 4$  have been obtained by resolution of the least squares problem:

$$\{a_j\}_{j=0:4} = \arg \min_{a_j} \sum_{i=1}^{68} (f(V_{\text{comp}}^i, m_{\text{fr}}^i) - T_e^i)^2,$$

where  $(V_{\text{comp}}^i, m_{\text{fr}}^i, T_e^i)_{i=1:68}$  are the points of the experimental data set. The obtained values of  $a_j$ ,  $j = 0 : 4$  are given here after:

$$\begin{aligned} a_0 &= -1.122, & a_1 &= -3.025 \cdot 10^2, & a_2 &= 1.386 \cdot 10^4, \\ a_3 &= -1.370, & a_4 &= 2.687 \cdot 10^{-2}. \end{aligned} \quad (33)$$

As an illustration, the curve of the estimated  $G_c$  as a function of  $V_{\text{comp}}$  ( $m_{\text{fr}}$  being kept constant and equal to  $25 \text{ kg}\cdot\text{h}^{-1}$ ) is plotted in Figure 5b. and compared to the experimental data used for the identification. As we can see, the qualitative behavior of the function is good. However, we also note that, from one experiment to the other, there can be large differences ( $2^\circ\text{C}$  or more) between the evaporation temperature values. In the control point of view, this “modeling error” can be compensated by the control law, because it only affects the gain, and not the dynamics of  $T_e$ . But, to compare the evaporation temperature measurement data with the model (30), we have introduced in the sequel an additive adjustment parameter  $\theta_i$ , which depends on the experimental data set under consideration: this parameter enables to compensate the static error. For the  $i^{\text{th}}$  experimental data set, we will therefore have :

$$G^c(V_{\text{comp}}, m_{\text{fr}}) = f(V_{\text{comp}}, m_{\text{fr}}) + \theta_i, \theta_i \in \mathbb{R}. \quad (34)$$

As we shall see in paragraph 6, this constant adjustment parameter will be sufficient to get a good approximation of  $T_e$ . It corresponds to a translation of the graph of function  $f$ .

## 6. Comparison between some simulated trajectories and experimental data

For illustration, we show in Figure 6 an example of trajectories obtained by simulation of model (16-20), after identification of parameters  $h_e$  and  $\chi$  from experimental data. Their identified values are given here after:

$$h_e = 3.106 \cdot 10^3 \text{ [W.m}^{-2}\text{.K}^{-1}\text{]}, \chi = 3.117 \cdot 10^{-3} \text{ [-]}. \quad (35)$$

For the considered experiment (denoted experiment A in the sequel), the mass flow rate  $m_{fr}$  and the scraper rotation speed  $N_{scrap}$  were constant and respectively equal to  $50 \text{ kg.h}^{-1}$  and  $750 \text{ rpm}$ . The profile of  $T_e$  is the one given in Figure 7. The simulated saturation temperature is compared to the whole set of experimental data, including the data used for the identification of  $h_e$  and  $\chi$ , and the ones saved for the cross validation. We have:

$$\sum_{k=1}^K \left| \frac{T_{sat}^{(16-20)}(t^{k,i}) - T_{sat,m}^{k,i}}{T_{sat,m}^{k,i}} \right| (t^{k,i} - t^{k-1,i}) = 1.342 \cdot 10^{-2}, \quad (36)$$

where  $T_{sat}^{(16-20)}(t^{k,i})$  is the value of the saturation temperature at time  $t^{k,i}$  obtained by simulation of model (16-20).

**Remark 2.** The results obtained with another experimental data set (denoted experiment B in the sequel) are given in Figure 10. For this data set,



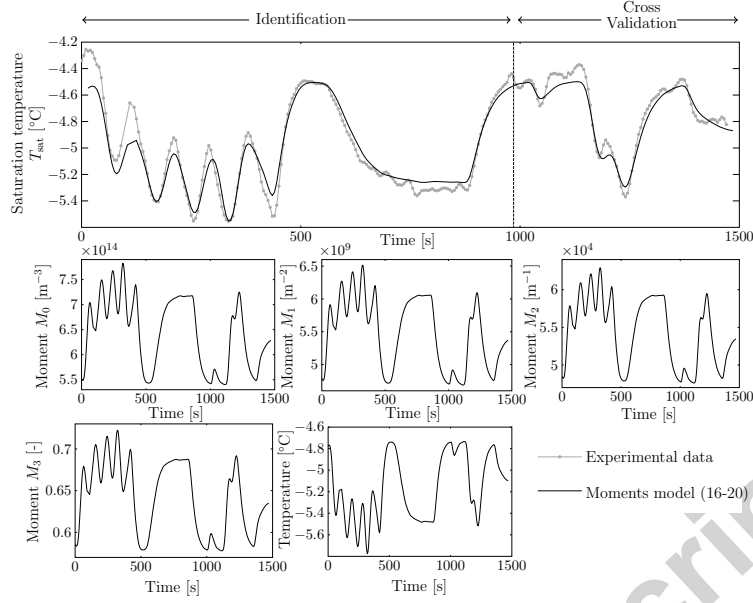

Figure 6: **Parameters identification of the freezer model:** simulated trajectories of the state variables of the identified model, and comparison of the simulated saturation temperature with experimental data (experiment A:  $m_{fr} = 50 \text{ kg}\cdot\text{h}^{-1}$  and  $N_{scrap} = 750 \text{ rpm}$ ).

the quantity defined in (36) is equal to  $3.559 \cdot 10^{-3}$ .

In Figure 7, the model of the compressor (30), with the identified value (31) of  $\tau_c$  and the identified expression (34,33) of  $G_c$ , is compared with one experimental data set which has not been used for the identification process of  $\tau_c$  and  $G_c$  (cross validation). These data correspond to the experiment A (presented in Figure 6). The adjustment parameter  $\theta_i$  is taken equal to  $0.3012 \text{ }^\circ\text{C}$ . It has been estimated from the first 2/3 of the data set by means of the State Variable Filter (SVF) method. As we can see, the value of  $T_c$  obtained by simulation of the model is close to the experimental data values on the whole data set (identification and cross validation parts).

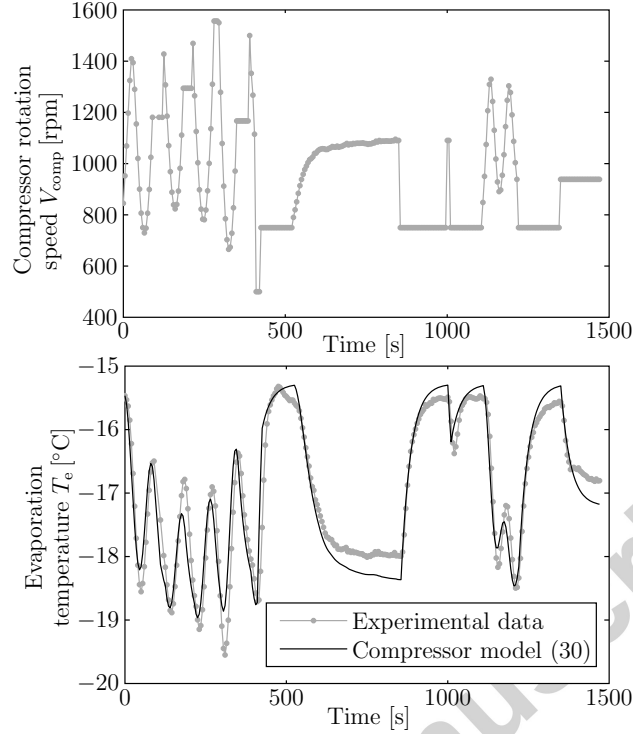

Figure 7: **Model of the compressor - cross validation.** Top: compressor rotation speed  $V_{\text{comp}}$ . Bottom: evaporation temperature  $T_e$ , comparison between experimental data and simulated values. (experiment A:  $m_{\text{fr}} = 50 \text{ kg}\cdot\text{h}^{-1}$  and  $N_{\text{scrap}} = 750 \text{ rpm}$ )

## 7. Model reduction

As shown in the previous sections of the paper, the model (16-20) well describes the input-output behavior of the crystallizer. However, when looking at the simulated trajectories of the model (see Figure 6), we observe that the dynamics of the moments  $M_0$ ,  $M_1$ ,  $M_2$  and  $M_3$  are close to each other, which suggests that the model could be simplified.

In the control problem point of view, the most important variable of the model is the third moment  $M_3$  on which depends the variable to be controlled, that is the saturation temperature  $T_{\text{sat}}$ . The equation of  $M_3$  only depends

explicitly on  $M_3$ ,  $M_2$ ,  $T$  and the inputs  $m_{fr}$  and  $T_e$ . The link with the other state variables  $M_0$  and  $M_1$  is only made through the variable  $M_2$ . As a consequence, if we can find a relation between  $M_2$  and  $M_3$ , then we will get a reduced order model only composed of the equations of  $M_3$  and  $T$ .

### 7.1. Mean crystal size and approximation of $M_1$ and $M_2$

Assuming crystals of spherical shape, the mean crystal size, denoted  $L_{\text{mean}}$  in the sequel, can be expressed as the quotient of  $M_1$ , that is the sum of crystals lengths, by  $M_0$ , that is the total number of crystals:

$$L_{\text{mean}} = \frac{M_1}{M_0}. \quad (37)$$

The moment  $M_3$  represents the sum of the volumes of the crystals. By dividing  $M_3$  by  $L_{\text{mean}}$ , we get a quantity which is representative of the sum of the areas of the crystals. As a consequence, it can be compared to the moment  $M_2$  which also quantify the total area of ice crystals.

Let us first compare the quantities  $M_2$  and  $\frac{M_0}{M_1}M_3$  in terms of their dynamic equations. We have:

$$\begin{aligned} \frac{d}{dt} \left( \frac{M_0}{M_1} M_3 \right) &= \frac{dM_3}{dt} \frac{M_0}{M_1} + \frac{M_3}{M_1^2} \left( \frac{dM_0}{dt} M_1 - M_0 \frac{dM_1}{dt} \right) \\ &= -D \frac{M_0}{M_1} M_3 + G \left( 3 \frac{M_0}{M_1} M_2 - \frac{M_0^2}{M_1^2} M_3 \right) \\ &\quad + N \left( \frac{M_0}{M_1} L_c^3 + \frac{M_3}{M_1} - \frac{M_0 M_3}{M_1^2} L_c \right) + B \left( 1 - c_1 \frac{M_2 M_0}{M_1^2} \right) M_3. \end{aligned}$$

Assume now that  $M_2$  is proportional to  $\frac{M_0}{M_1} M_3$ , and  $M_1$  is proportional to

$\frac{M_0}{M_1}M_2$  and denote  $\eta_2$  and  $\eta_1$  the proportionality coefficients:

$$M_2 \simeq \eta_2 \frac{M_0}{M_1} M_3, \text{ and } M_1 \simeq \eta_1 \frac{M_0}{M_1} M_2. \quad (38)$$

We then have  $\eta_2 \frac{M_0}{M_1} M_2 \simeq \frac{\eta_2}{\eta_1} M_1$  and  $\eta_2 \frac{M_0^2}{M_1^2} M_3 \simeq \frac{M_0}{M_1} M_2 \simeq \frac{1}{\eta_1} M_1$ , so that :

$$3\eta_2 \frac{M_0}{M_1} M_2 - \eta_2 \frac{M_0^2}{M_1^2} M_3 \simeq \frac{3\eta_2 - 1}{\eta_1} M_1. \quad (39)$$

In the same way, we get:

$$\eta_2 \left( 1 - c_1 \frac{M_2 M_0}{M_1^2} \right) \simeq \frac{\eta_2 (\eta_1 - c_1)}{\eta_1}, \quad (40)$$

and:

$$\eta_2 \left( \frac{M_0}{M_1} L_c^3 + \frac{M_3}{M_1} - \frac{M_0 M_3}{M_1^2} L_c \right) \simeq \eta_2 \frac{L_c^3}{L_{\text{mean}}} + \frac{1}{\eta_1} L_{\text{mean}}^2 - \frac{1}{\eta_1} L_{\text{mean}} L_c. \quad (41)$$

Let us denote  $\tilde{L}_c^2$  the positive quantity  $\eta_2 \frac{L_c^3}{L_{\text{mean}}} + \frac{1}{\eta_1} L_{\text{mean}}^2 - \frac{1}{\eta_1} L_{\text{mean}} L_c$ .

We finally get:

$$\frac{d}{dt} \left( \eta_2 \frac{M_0}{M_1} M_3 \right) \simeq -DM_2 + \frac{3\eta_2 - 1}{\eta_1} GM_1 + N\tilde{L}_c^2 + \frac{\eta_2 (\eta_1 - c_1)}{\eta_1} BM_3, \quad (42)$$

$$\text{whereas } \frac{dM_2}{dt} = -DM_2 + 2GM_1 + NL_c^2 + c_2 BM_3. \quad (43)$$

As we can see, both equations (42) and (43) have the same structure. The differences between the two equations can be expressed as variations of the values of the parameters  $\beta$ ,  $\epsilon$  and  $L_c$ . Indeed, equation (42) can be written exactly with the same expression than the equation (43), but with:

- $\tilde{\beta} := \frac{3\eta_2-1}{2\eta_1}\beta$  in place of  $\beta$ ,
- $\tilde{\epsilon} := \frac{\eta_2(\eta_1-c_1)}{c_2\eta_1}\epsilon$  in place of  $\epsilon$ ,
- $\tilde{L}_c$  in place of  $L_c$ .

According to the sensitivity analysis performed in paragraph 4.1 (see Figure 3), it clearly appears that the parameters  $\beta$  and  $\epsilon$  do not influence the value of  $M_2$  a lot. As a consequence, if  $\tilde{\beta}$  and  $\tilde{\epsilon}$  are respectively close to  $\beta$  and  $\epsilon$ , then, the difference between the growth and breakage terms of the two equations will be negligible.

The parameter  $\tilde{L}_c$  is not constant because it depends on  $L_{\text{mean}} := \frac{M_1}{M_0}$ . By simple computations, we can show that, if  $1 > \eta_1\eta_2$ , the function  $L_{\text{mean}} \mapsto \eta_2 \frac{L_c^3}{L_{\text{mean}}} + \frac{1}{\eta_1} L_{\text{mean}}^2 - \frac{1}{\eta_1} L_{\text{mean}} L_c$  is increasing<sup>9</sup> on the interval  $[L_c, +\infty)$ . Moreover, some experimental studies performed on the process (Arellano et al., 2012) have shown that, in the range of admissible input controls values (see Table 1), and for the same commercial mix than the one considered in this work, the mean crystal size  $L_{\text{mean}}$  at the outlet of the freezer ranged from  $5\mu\text{m} = L_c$  to  $9\mu\text{m} < 2L_c$ .

Under the hypothesis that  $L_c < L_{\text{mean}} < 2L_c$ , we then conclude that:

$$\eta_2 L_c^2 < \underbrace{\eta_2 \frac{L_c^3}{L_{\text{mean}}} + \frac{1}{\eta_1} L_{\text{mean}}^2 - \frac{1}{\eta_1} L_{\text{mean}} L_c}_{\tilde{L}_c^2} < \frac{\eta_1\eta_2+4}{2\eta_1} L_c^2. \quad (44)$$

As a consequence, if  $\sqrt{\eta_2}$  and  $\sqrt{\frac{\eta_1\eta_2+4}{2\eta_1}}$  are close to 1, then the difference

---

<sup>9</sup>The derivative of the function is given by  $f'(L_{\text{mean}}) = \frac{1}{\eta_1 L_{\text{mean}}^2} (-\eta_1\eta_2 L_c^3 + 2L_{\text{mean}}^3 - L_c L_{\text{mean}}^2)$  and is such that  $f'(L_{\text{mean}}) > 0, \forall L_{\text{mean}} \geq L_c$ , if  $1 > \eta_1\eta_2$ .

between  $L_c$  and  $\tilde{L}_c$  will always remain small, which, according to the sensitivity analysis performed in Section 4.1 (see Figure 3), will lead to only small differences between the corresponding values of  $M_2$ .

Finally, if  $1 > \eta_1 \eta_2$ ,  $\frac{3\eta_2-1}{2\eta_1}$ ,  $\frac{\eta_2(\eta_1-c_1)}{c_2\eta_1}$ ,  $\sqrt{\eta_2}$  and  $\sqrt{\frac{\eta_1\eta_2+4}{2\eta_1}}$  are close to 1, than the approximation:

$$M_2 \simeq \eta_2 \frac{M_0}{M_1} M_3 \quad (45)$$

can be justified.

Let us check this approximation on some simulations of the model identified from experiment A data (see Figure 6). In Figure 8, are given the plots of  $\frac{M_0}{M_1} M_3$  versus  $M_2$ , and  $\frac{M_0}{M_1} M_2$  versus  $M_1$  of 2 simulations: the one presented in Figure 6 for comparison with the experimental data (simulated data 1), and the simulated response to a random series of steps<sup>10</sup> of  $V_{\text{comp}}$  (simulated data 2). Both plots exhibit a proportional relationship between the two variables, which, in that case, validates the assumption (38).

The estimated values<sup>11</sup> of  $\eta_1$  and  $\eta_2$  are given here after:

$$\eta_1 = 0.8627 \text{ and } \eta_2 = 0.7262, \quad (46)$$

---

<sup>10</sup>The input  $V_{\text{comp}}$  is composed of 40 successive steps, the values of which have been randomly chosen in the set  $\{200 \times k, k = 1 : 13\}$ . Each step lasts 300 s, so that the global simulation is 12 000 s long. With such an input, the range of simulated  $M_3$  values is maximal.

<sup>11</sup>These values have been estimated from the simulated response to the  $V_{\text{comp}}$  steps input (simulated data 2) by use of the least squares method.

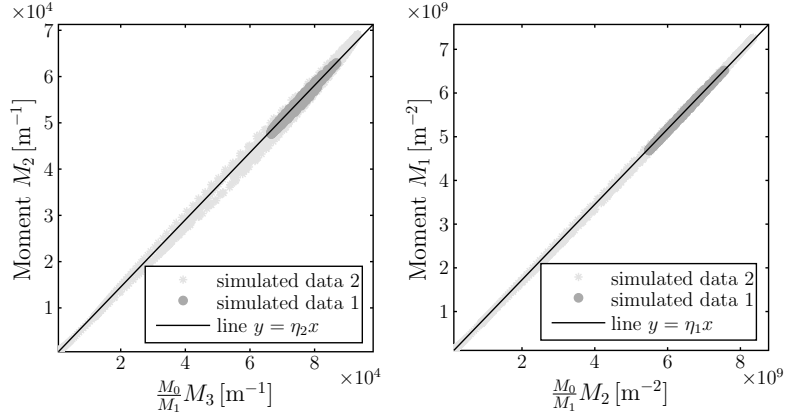

Figure 8: **Approximation of moments  $M_2$  and  $M_1$** : plots of  $M_2$  versus  $\frac{M_0}{M_1}M_3$ , and  $M_1$  versus  $\frac{M_0}{M_1}M_2$ . The proportionality coefficients  $\eta_1$  and  $\eta_2$  are respectively equal to 0.8627 and 0.7262. (experiment A:  $m_{fr} = 50 \text{ kg.h}^{-1}$  and  $N_{scrap} = 750 \text{ rpm}$ )

which leads to:

$$\frac{3\eta_2 - 1}{2\eta_1} = 0.6832, \quad \frac{\eta_2(\eta_1 - c_1)}{c_2\eta_1} = 0.8916,$$

$$\sqrt{\eta_2} = 0.8522, \quad \text{and} \quad \sqrt{\frac{\eta_1\eta_2 + 4}{2\eta_1}} = 1.638.$$

For the simulated trajectories presented in Figure 6 (experiment A), we have:

$$e_{M_1} := \frac{1}{T} \int_{t_0}^{t_0+T} \left| \frac{M_1(t) - \eta_1 \frac{M_0(t)}{M_1(t)} M_2(t)}{M_1(t)} \right| dt = 4.651 \cdot 10^{-3},$$

$$e_{M_2} := \frac{1}{T} \int_{t_0}^{t_0+T} \left| \frac{M_2(t) - \eta_2 \frac{M_0(t)}{M_1(t)} M_3(t)}{M_2(t)} \right| dt = 8.690 \cdot 10^{-3}.$$

The results obtained with the experiment B are given in Figure 10. For this data set we obtain the following values:

$$\eta_1 = 0.8943, \quad \eta_2 = 0.7765, \quad e_{M_1} = 7.565 \cdot 10^{-3}, \quad e_{M_2} = 1.876 \cdot 10^{-2}. \quad (47)$$

The values of  $\eta_1$  and  $\eta_2$  have been computed for each of the 12 experiments. The standard deviation and the minimal, maximal and mean values of  $\eta_1$  and  $\eta_2$  (on the set of the 12 experiments) are given in Table 9. We note that the standard deviation is not very large, which means that the values of  $\eta_1$  and  $\eta_2$  do not vary a lot from experiment to the other.

	min	max	mean	standard deviation
$\eta_1$	0.8529	0.9207	0.8918	0.02101
$\eta_2$	0.7077	0.8287	0.7757	0.03692
$b_1$	$6.001 \cdot 10^4$	$1.177 \cdot 10^5$	$8.713 \cdot 10^4$	$2.069 \cdot 10^4$
$b_2$	$9.911 \cdot 10^3$	$4.484 \cdot 10^4$	$2.890 \cdot 10^4$	$1.113 \cdot 10^4$

Table 9: **Identification of parameters for the reduced order model:** identified values of  $\eta_1$ ,  $\eta_2$ ,  $b_1$  and  $b_2$ . The standard deviation and the minimal, maximal and mean values are computed on the set of the 12 experiments.

## 7.2. Reduced order model

The mean crystal size  $L_{\text{mean}}$  is a quantity that can be measured (Arellano et al., 2012). If this measurement is available on-line, it can be viewed as an input of the following system composed of only two equations:

$$\frac{dM_3}{dt} = -DM_3 + 3G \frac{\eta_2}{L_{\text{mean}}} M_3 + NL_c^3 \quad (48)$$

$$\begin{aligned} \frac{dT}{dt} = & D(T_0 - T) + K_2(T_e - T) \\ & + N_{\text{scrap}}^2 K_3 \mu + K_1 \left( 3G \frac{\eta_2}{L_{\text{mean}}} M_3 + NL_c^3 \right). \end{aligned} \quad (49)$$

In the case where the measurement of  $L_{\text{mean}}$  is not available (as it is the case for the data sets considered in this paper), an estimation of  $L_{\text{mean}}$  has to be considered.

In Arellano et al. (2012), it is shown that when the evaporation temperature



decreases, the mean crystal size  $L_{\text{mean}}$  decreases, whereas the ice mass fraction  $\phi_i$  increases. In other words, the greater the ice mass fraction, the smaller the mean crystal size. As the ice mass fraction  $\phi_i$  is proportional to the moment  $M_3$  (see (12)), we can therefore express  $L_{\text{mean}}$  as a decreasing function of the moment  $M_3$  (except in the neighbourhood of  $M_3 = 0$  where the mean crystal size has to be equal to 0). According to the results presented in Arellano et al. (2012), this function does not depend significantly on the dasher rotation speed  $N_{\text{scrap}}$ , but can vary with the mass flow rate  $m_{\text{fr}}$ . We so have:

$$L_{\text{mean}} = L_{\text{mean}}(m_{\text{fr}}, M_3), \quad (50)$$

and so, from (45):

$$M_2 \simeq \eta_2 \frac{1}{L_{\text{mean}}(m_{\text{fr}}, M_3)} M_3 := M_2(m_{\text{fr}}, M_3), \quad (51)$$

where  $M_3 \mapsto M_2(m_{\text{fr}}, M_3)$  is a positive function which is increasing when  $M_3 \mapsto L_{\text{mean}}(m_{\text{fr}}, M_3)$  is decreasing<sup>12</sup>. This finally leads to the following reduced order model:

$$\frac{dM_3}{dt} = -DM_3 + 3GM_2(m_{\text{fr}}, M_3) + NL_c^3 \quad (52)$$

$$\begin{aligned} \frac{dT}{dt} = & D(T_0 - T) + K_2(T_e - T) \\ & + N_{\text{scrap}}^2 K_3 \mu + K_1 (3GM_2(m_{\text{fr}}, M_3) + NL_c^3). \end{aligned} \quad (53)$$

---

<sup>12</sup>The derivative of function  $f : M_3 \mapsto M_2(m_{\text{fr}}, M_3)$  is given by  $f'(M_3) = \frac{1}{L_{\text{mean}}(m_{\text{fr}}, M_3)^2} (\eta_2 L_{\text{mean}}(m_{\text{fr}}, M_3) - \eta_2 \partial_{M_3} [L_{\text{mean}}(m_{\text{fr}}, M_3)] M_3)$ .

The determination of the expression of  $L_{\text{mean}}(m_{\text{fr}}, M_3)$  can be made from experimental measurements of the mean crystal size, as the ones presented in Arellano et al. (2012). However, in our case, recall that the objective is to get a model which accurately describes the time evolution of the saturation temperature, in an input-output point of view. As a consequence, the identification of  $L_{\text{mean}}(m_{\text{fr}}, M_3)$  (and of  $M_2(m_{\text{fr}}, M_3)$ ) will be made directly from the numerical simulations.

Consider the model identified from experiment A data (Figure 6), for which  $m_{\text{fr}} = 50 \text{ kg}\cdot\text{h}^{-1}$ . The plots of  $M_2$  versus  $M_3$ , and  $\frac{M_1}{M_0}$  ( $= L_{\text{mean}}$ ) versus  $M_3$  are given in Figure 9 for the simulated data 1 (experiment A simulated trajectories) and 2 (simulated response to the  $V_{\text{comp}}$  steps input). The plot of  $M_2$  versus  $M_3$  shows a relationship between the two variables close to a line. However, to be physically realistic, the function  $M_3 \mapsto M_2(m_{\text{fr}}, M_3)$  has to be such that  $M_2(m_{\text{fr}}, 0) = 0$ . As a consequence, we have considered a function of the form:

$$M_2(m_{\text{fr}}, M_3) = M_3^\lambda [b_1(m_{\text{fr}})M_3 + b_2(m_{\text{fr}})], \lambda > 0. \quad (54)$$

To obtain a good estimation of  $L_{\text{mean}}$ , we also need to have  $L_{\text{mean}}(m_{\text{fr}}, 0) = 0$  (see the plot of  $\frac{M_1}{M_0}$  versus  $M_3$ ), which leads to the constraint  $\lambda < 1$  (because from (51),  $L_{\text{mean}}(m_{\text{fr}}, M_3) = \eta_2 M_3^{1-\lambda} / [b_1(m_{\text{fr}})M_3 + b_2(m_{\text{fr}})]$ ). Several values of  $\lambda$  have been tested. The functions identified with the least squares method from the simulated data 2 are plotted in Figure 9. The identified functions  $M_3 \mapsto L_{\text{mean}}(50, M_3)$  and  $M_3 \mapsto M_2(50, M_3)$  obtained with  $\lambda = 3/4$  are the ones which fit the simulated data at best. The corresponding identified

values of  $b_1(50)$  and  $b_2(50)$  are given here after :

$$b_1(50) = 6.001 \cdot 10^4, \quad b_2(50) = 3.731 \cdot 10^4. \quad (55)$$

Some experimental data taken from the paper of Arellano et al. (2012)

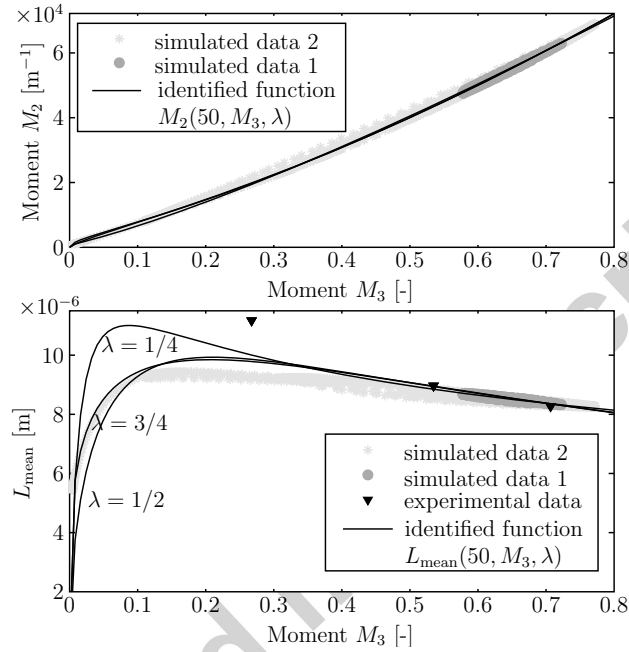

Figure 9: **Reduced order model:** plots of  $M_2$  versus  $M_3$ , and  $L_{\text{mean}}$  versus  $M_3$  for identification of the functions  $M_3 \mapsto M_2(m_{\text{fr}}, M_3)$  and  $M_3 \mapsto L_{\text{mean}}(m_{\text{fr}}, M_3)$ . (experiment A:  $m_{\text{fr}} = 50 \text{ kg}\cdot\text{h}^{-1}$  and  $N_{\text{scrap}} = 750 \text{ rpm}$ )

have also been considered for comparison with the identification function  $L_{\text{mean}}(50, M_3)$ . Among the 15 experiments presented in Arellano et al. (2012), 3 have been performed<sup>13</sup> with the same values of the mass flow rate and the dasher rotation speed than the ones used for the numerical simulation of

<sup>13</sup>The 3 experiments we are talking about are the runs number 10, 13 and 14 of Table 1 in Arellano et al. (2012).

Figure 9, that is  $m_{fr} = 50 \text{ kg.h}^{-1}$  and  $N_{scrap} = 750 \text{ rpm}$ . The 3 experiments are presented in Table 10 in which the evaporation temperature, and the mean values of both the ice mass fraction and the mean chord length are given. The 3 experimental data points represented in Figure 9 correspond to

$T_e$ [°C]	mean chord length [ $\mu\text{m}$ ]	$\phi_i$ [%]
$-15.3 \pm 0.1$	$6.5 \pm 0.2$	28
$-19.8 \pm 0.1$	$6 \pm 0.2$	37
$-10.6 \pm 0.1$	$8.1 \pm 0.1$	14

Table 10: **Experimental data from the paper Arellano et al. (2012)**: evaporation temperature, mean chord length and ice fraction values measured during a crystallization performed with  $m_{fr} = 50 \text{ kg.h}^{-1}$  and  $N_{scrap} = 750 \text{ rpm}$ .

these 3 experiments. The plotted values have been deduced from the values given in Table 10 in the following way:

- the value of  $M_3$  is deduced from  $\phi_i$  by the relation (12).
- the value of  $L_{\text{mean}}$  is not directly equal to the Mean Chord Length (MCL). Indeed, as explained in Wynn (2003), the MCL of a sphere is  $\pi/4 \simeq 0.785$  times smaller than its diameter. This value is nevertheless theoretical; the values of  $L_{\text{mean}}$  in Figure 9 are obtained by dividing the MCL by 0.725.

The identified function  $L_{\text{mean}}(50, M_3)$ , and the quantity  $\frac{M_1}{M_0}$ , give a good estimation of the mean crystal size for the largest values of  $M_3$ . For small values of  $M_3$ , the estimation is less good, but the qualitative behavior remains consistent.

The values of  $b_1(m_{fr})$  and  $b_2(m_{fr})$  have been computed for each of the 12 experiments considered in this paper. The standard deviation and the

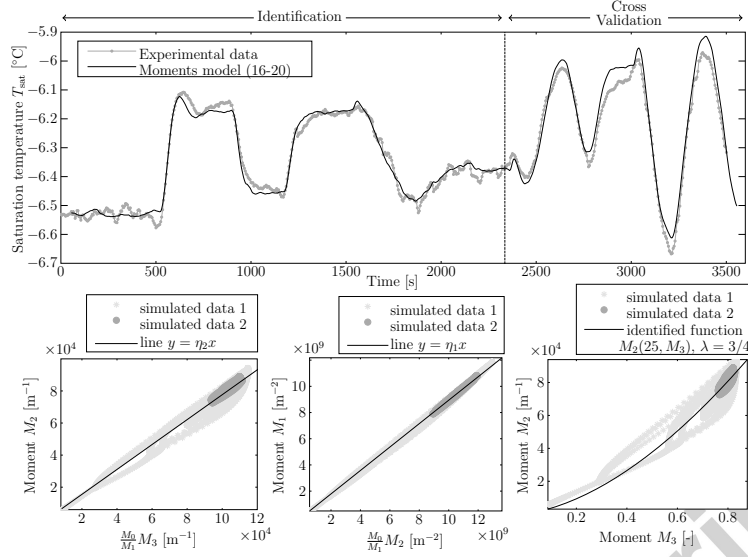

Figure 10: **Parameters identification of the freezer model:** Top: simulated trajectories of the saturation temperature and comparison with experimental data. Bottom: plots of  $M_2$  versus  $\frac{M_0}{M_1} M_3$ ,  $M_1$  versus  $\frac{M_0}{M_1} M_2$ , and  $M_2$  versus  $M_3$ . (experiment B:  $m_{fr} = 25 \text{ kg}\cdot\text{h}^{-1}$  and  $N_{scrap} = 750 \text{ rpm}$ ).

minimal, maximal and mean values of  $b_1(m_{fr})$  and  $b_2(m_{fr})$  (on the set of the 12 experiments) are given in Table 9. For all the 12 experiments, the approximation (54) with  $\lambda = 3/4$  leads to a good input-output approximation of the system. The results obtained with the experiment B are given in Figure 10. For this data set, we get the following identified values:

$$b_1(25) = 1.070 \cdot 10^5, \quad b_2(25) = 9.911 \cdot 10^3. \quad (56)$$

## 8. Comparison between the reduced order model (52-54) and the moments model (16-20)

To validate the reduced order model (52-54), the steady states values of the model are first compared with the ones of the moments model (16-20). Unfortunately, due to the complexity of these models and because it depends on the expressions of  $T_{\text{sat}}$  and  $\mu$ , neither the values nor the number of equilibrium points can be analytically computed. However, these quantities can be computed numerically for some given values of the model parameters and several set of admissible physical values of the input variables (see Casenave et al. (2012) for a steady-states analysis of the moments model (16-20)).

In Figure 11, the computed steady-states values of both models (52-54) and (16-20) are given for different values of the evaporation temperature  $T_e$  and the dasher rotation speed  $N_{\text{scrap}}$ . For the computation, the set of model parameters is the one used for experiment B (see Figure 10). The mass flow rate is equal to  $25 \text{ kg}\cdot\text{h}^{-1}$  and the function  $M_3 \mapsto M_2(25, M_3)$  is assumed to be of the form (54) with the values of  $b_1(25)$  and  $b_2(25)$  given in (56) and with  $\lambda = 3/4$ . As we can see, the steady-states values of the two models are really close to each other, which is a first validation of the reduced order model. Similar results are obtained for other values of the mass flow rate  $m_{\text{fr}}$ .

To go further in the validation of the reduced order model, we also have compared the trajectory of the saturation temperature  $T_{\text{sat}}$  obtained by the simulation of model (52-54) with the one obtained by the simulation of the moments model (16-20). Consider the data set of experiment A (see Figure 6). In that case, the trajectories obtained by simulation of both models are

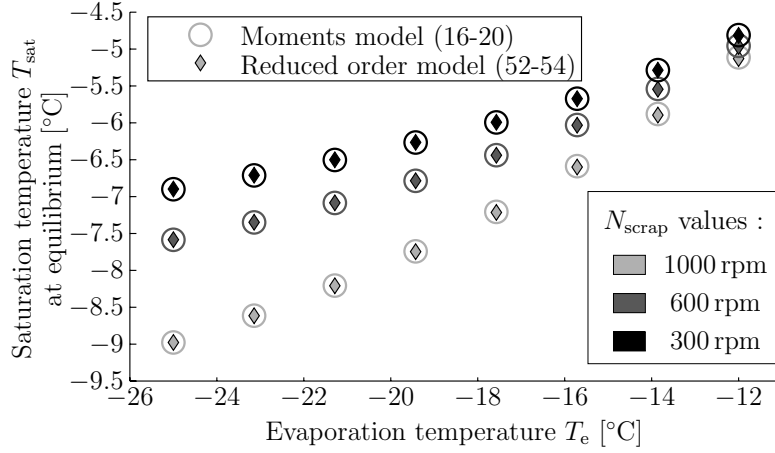

Figure 11: **Steady states comparison between the reduced order model (52-54) and the moments model (16-20)**. (experiment B:  $m_{fr} = 25 \text{ kg.h}^{-1}$ )

so close to each other that we cannot distinguish them when they are plotted on the same figure. We indeed have :

$$\frac{1}{T} \int_{t_0}^{t_0+T} \left| \frac{T_{\text{sat}}^{(16-20)}(t) - T_{\text{sat}}^{(52-54)}(t)}{T_{\text{sat}}^{(16-20)}(t)} \right| dt = 6.850 \cdot 10^{-5}, \quad (57)$$

where  $T_{\text{sat}}^{(16-20)}$  (respectively  $T_{\text{sat}}^{(52-54)}$ ) is the trajectory obtained by the simulation of model (16-20) (respectively model (52-54)). For the experiment B (see Figure 10), this quantity is equal to  $8.587 \cdot 10^{-5}$ .

## 9. Conclusion

The present paper focuses on the identification and the reduction of a model of an ice cream crystallization process. The model which is initially considered is a dynamic version of the one presented in Arellano et al. (2013) and Gonzalez et al. (2011). It is composed of 5 ordinary differential equations which describe the dynamics of the 4 first moments of the CSD and of the ice

temperature. The first part of the paper consists in the identification of the model parameters whereas the second part focuses on the model reduction. It is shown that, to accurately describe the input-output behavior of the system (the input and output variables being respectively the evaporation temperature and the saturation temperature) whatever the conditions are, it is sufficient to consider a reduced order model composed of 2 ODEs (one for the third moment  $M_3$  and one for the ice temperature  $T$ ) and to modify the values of only two model parameters: the convective heat transfer coefficient  $h_e$ , and the viscous dissipation coefficient  $\chi$ . In a control point of view, it has a real interest: adaptive control techniques can indeed be used to modify the values of  $h_e$  and  $\chi$  in such a way that the process is controlled in all conditions.

Coupling with a black box model (first order equation with a nonlinear gain) for the modeling of the compressor, the reduced order model of the crystallization process is finally written:

$$\begin{aligned}\frac{dM_3}{dt} &= -DM_3 + 3GM_2 + NL_c^3 \\ \frac{dT}{dt} &= D(T_0 - T) + K_2(T_e - T) + N_{\text{scrap}}^2 K_3 \mu + K_1(3GM_2 + NL_c^3) \\ \frac{dT_e}{dt} &= -\frac{1}{\tau_c} T_e + \frac{1}{\tau_c} G^c(V_{\text{comp}}, m_{\text{fr}}),\end{aligned}$$

with  $\mu = \mu(M_3, T, N_{\text{scrap}}, \chi)$ ,  $G = G(M_3, T)$ ,  $N = N(M_3, T_e)$ ,  $K_2 = K_2(h_e)$ ,  $K_3 = K_3(\chi)$  and  $M_2 = M_2(m_{\text{fr}}, M_3) = M_3^\lambda [b_1(m_{\text{fr}})M_3 + b_2(m_{\text{fr}})]$ .

The problem of the control of the ice cream viscosity will be studied in a further paper, on the basis of this model.



## References

- Arellano, M., Benkhelifa, H., Alvarez, G., Flick, D., 2013. Coupling population balance and residence time distribution for the ice crystallization modeling in a scraped surface heat exchanger. *Chemical Engineering Science* 102, 502–513.
- Arellano, M., Benkhelifa, H., Flick, D., Alvarez, G., 2012. Online ice crystal size measurements during sorbet freezing by means of the focused beam reflectance measurement (FBRM) technology. Influence of operating conditions. *Journal of Food Engineering* 113, 351–359.
- Bernard, O., Hadj-Sadok, Z., Dochain, D., Genovesi, A., Steyer, J.P., 2001. Dynamical model development and parameter identification for an anaerobic wastewater treatment process. *Biotechnology and bioengineering* 75, 424–438.
- Casenave, C., Dochain, D., Alvarez, G., Benkhelifa, H., Flick, D., Leducq, D., 2012. Steady-state and stability analysis of a population balance based nonlinear ice cream crystallization model, in: *American Control Conference (ACC), IEEE*, june 27-29 2012, Montréal (Canada). pp. 6461–6466.
- Christofides, P., 2002. Nonlinear model reduction and control of particulate processes, in: *Particle Technology Series: Model-Based Control of Particulate Processes*. Springer. volume 14, pp. 9–33.
- Christofides, P., El-Farra, N., Li, M., Mhaskar, P., 2008. Model-based control of particulate processes. *Chemical Engineering Science* 63, 1156–1172.

- Cook, K., Hartel, R., 2010. Mechanisms of Ice Crystallization in Ice Cream Production. *Comprehensive Reviews in Food Science and Food Safety* 9, 213–222.
- Costa, C., Maciel, M., Filho, R., 2007. Considerations on the crystallization modeling: Population balance solution. *Computers & Chemical Engineering* 31, 206–218.
- Dokucu, M.T., Park, M.J., Doyle III, F.J., 2008. Reduced-order methodologies for feedback control of particle size distribution in semi-batch emulsion copolymerization. *Chemical Engineering Science* 63, 1230–1245.
- Garnier, H., Young, P., 2004. Time-domain approaches to continuous-time model identification of dynamical systems from sampled data, in: *American Control Conference*, June 30 - July 2 2004, Barcelona, Spain. pp. 667–672.
- Gonzalez, J.E., 2012. Contribution au contrôle par la modélisation d'un procédé de cristallisation en continu. Ph.D. thesis. Agroparistech.
- Gonzalez, J.E., Arellano, M., Leducq, D., Alvarez, G., Benkhelifa, H., Flick, D., 2011. Moments model for a continuous sorbet crystallization process, in: *The 23rd IIR International Congress of Refrigeration*. August 21-26 2011, Prague, Czech Republic.
- Hartel, R.W., 2001. *Crystallization in foods*. Aspen Publishers Gaithersburg.
- Ma, C.Y., Wang, X.Z., 2012. Closed-loop control of crystal shape in cooling crystallization of l-glutamic acid. *Journal of Process Control* 22, 72–81.

- Mantzaris, N.V., Daoutidis, P., 2004. Cell population balance modeling and control in continuous bioreactors. *Journal of Process Control* 14, 775–784.
- Mesbah, A., Nagy, Z.K., Huesman, A.E.M., Kramer, H.J.M., Van den Hof, P.M.J., 2012. Nonlinear model-based control of a semi-industrial batch crystallizer using a population balance modeling framework. *Control Systems Technology, IEEE Transactions on* 20, 1188–1201.
- Motz, S., Mannel, S., Gilles, E.D., 2004. Integral approximation - an approach to reduced models for particulate processes. *Chemical Engineering Science* 59, 987–1000.
- Mullin, J., 2001. *Crystallization*. Butterworth-Heinemann.
- Nagy, Z.K., 2008. A population balance model approach for crystallization product engineering via distribution shaping control. *Computer Aided Chemical Engineering* 25, 139–144.
- Nagy, Z.K., Chew, J.W., Fujiwara, M., Braatz, R.D., 2008. Comparative performance of concentration and temperature controlled batch crystallizations. *Journal of Process Control* 18, 399–407.
- Randolph, A., 1971. *Theory of particulate processes: analysis and techniques of continuous crystallization*. Academic press.
- Rawlings, J., Miller, S., Witkowski, W., 1993. Model identification and control of solution crystallization processes: a review. *Industrial & Engineering Chemistry Research* 32, 1275–1296.

- Ray, W., 1978. Some recent applications of distributed parameter systems theory - A Survey. *Automatica* 14, 281–287.
- Sheikhzadeh, M., Trifkovic, M., Rohani, S., 2008. Real-time optimal control of an anti-solvent isothermal semi-batch crystallization process. *Chemical Engineering Science* 63, 829–839.
- Vollmer, U., Raisch, J., 2006. Control of batch crystallization - A system inversion approach. *Chemical Engineering and Processing: Process Intensification* 45, 874–885.
- Wynn, E., 2003. Relationship between particle-size and chord-length distributions in focused beam reflectance measurement: stability of direct inversion and weighting. *Powder Technology* 133, 125–133.
- Young, P.C., 2002. Optimal IV identification and estimation of continuous-time TF models, in: 15th Triennial IFAC world congress on automatic control, July 21-26 2002, Barcelona, Spain.